

FRENIC-Ace

For Solar Pumping



CE cUL LISTED



Specific Functions of Solar Pumping

- True and outstanding MPPT function (Maximum Power Point Tracking)
- Start criteria by system conditions and time
- Stop criteria selectable by frequency or power
- Dry pump detection function
- Low power function
- It allows to control asynchronous motors and permanent magnets synchronous motors
- Detection of sudden changes of conditions (especially irradiance)
- Two sets of PID gains, for a fast and smooth operation
- Water tank level control
- Grid connection selectable for maintenance and backup system

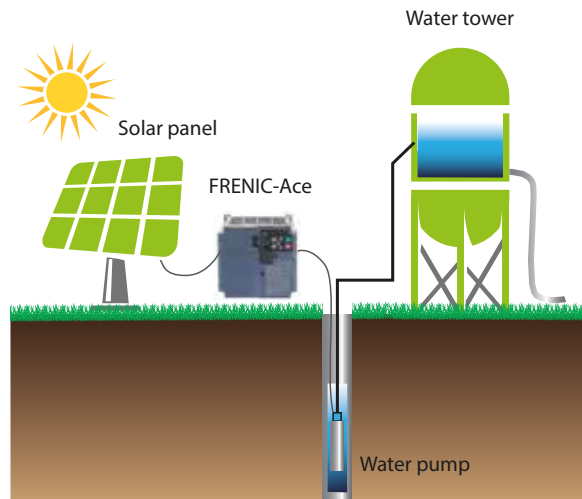

Generic specifications

	400 V Motor	200 V Motor
Maximum input voltage (Voc)	800 VDC	360 VDC
Minimum input voltage	400 VDC	180 VDC
Recommended voltage DC (VMPP)	550 - 620 VDC	280 - 330 VDC
Nominal input voltage AC	3ph 380 - 480 V, 50/60 Hz	3ph 200 - 240 V, 50/60 Hz
Nominal output voltage AC	3ph 400 V	3ph 200 V
Output frequency	0 - 400 Hz	
Efficiency (inverter)	97 - 98%	
Ambient temperature range	-10 to 50° C	
Cooling	Natural / by means of internal fan	
Recommended input power	1.2 times the pump capacity (minimum)	
Warranty	3 years	
EMC filter*1 / Motor output	Built-in / optional (from distances over 50 m)	

*1 For more information regarding EMC filters (AC/DC) please contact Fuji Electric.

Power Range and Dimensions

Motor (kW)	IP Class	Range [3ph 400 V]		IP Class	Range [3ph 200 V]		IP Class	Range [1ph 200 V]		Dimensions (mm)		
		Model	[A]*2		Model	[A]*2		Model	[A]*2	W	H	D
0.1												
0.2				IP20	FRN0001E2E-2GA-CLI-SOL	1.3	IP20	FRN0001E2E-7GA-CLI-SOL	0.8	68	127	112
0.4				IP20	FRN0002E2E-2GA-CLI-SOL	2	IP20	FRN0002E2E-7GA-CLI-SOL	1.6	68	127	112
0.75	IP20	FRN0004E2E-4GA-CLI-SOL	3.4	IP20	FRN0003E2E-2GA-CLI-SOL	3.0	IP20	FRN0003E2E-7GA-CLI-SOL	3.0	68	127	112/127
1.1	IP20	FRN0006E2E-4GA-CLI-SOL	5	IP20	FRN0004E2E-2GA-CLI-SOL	3.5	IP20	FRN0004E2E-7GA-CLI-SOL	5	110/68/110	130/127/130	162/127/129
1.5	IP20	FRN0006E2E-4GA-CLI-SOL	5	IP20	FRN0006E2E-2GA-CLI-SOL	6	IP20	FRN0005E2E-7GA-CLI-SOL	8	110/68/140	130/127/130	186/152/199
2.2	IP20	FRN0006E2E-4GA-CLI-SOL	5	IP20	FRN0010E2E-2GA-CLI-SOL	9.6	IP20	FRN0008E2E-7GA-CLI-SOL	8	140	130	199
3.0	IP20	FRN0007E2E-4GA-CLI-SOL	6.3	IP20	FRN0010E2E-2GA-CLI-SOL	9.6	IP20	FRN0008E2E-7GA-CLI-SOL	8	140	130	199
4	IP20	FRN0012E2E-4GA-CLI-SOL	11.1	IP20	FRN0012E2E-2GA-CLI-SOL	12	IP20	FRN0011E2E-7GA-CLI-SOL	11	140	130	199
5.5	IP20	FRN0012E2E-4GA-CLI-SOL	11.1	IP20	FRN0020E2E-2GA-CLI-SOL	19.6	IP20	FRN0020E2E-7GA-CLI-SOL	19.6	140	130	199
7.5	IP20	FRN0022E2E-4E-CLI-SOL	17.5	IP20	FRN0020E2E-2GA-CLI-SOL	19.6	IP20	FRN0020E2E-7GA-CLI-SOL	19.6	140	130	199
11	IP20	FRN0029E2E-4E-CLI-SOL	23	IP20	FRN0030E2S-2GB-CLI-SOL	30	IP20	FRN0030E2S-2GB-CLI-SOL	30	181.5/180	285/220	208/158
15	IP20	FRN0037E2E-4E-CLI-SOL	31	IP20	FRN0040E2S-2GB-CLI-SOL	40	IP20	FRN0040E2S-2GB-CLI-SOL	40	181.5/180	285/220	208/158
18.5	IP20	FRN0044E2E-4E-CLI-SOL	38	IP20	FRN0056E2S-2GB-CLI-SOL	56	IP20	FRN0056E2S-2GB-CLI-SOL	56	220/220	332/260	245/190
22	IP20	FRN0059E2E-4E-CLI-SOL	45	IP20	FRN0069E2S-2GB-CLI-SOL	69	IP20	FRN0069E2S-2GB-CLI-SOL	69	220/220	332/260	245/190
30	IP20	FRN0072E2E-4E-CLI-SOL	60	IP20	FRN0088E2S-2GB-CLI-SOL	88	IP20	FRN0088E2S-2GB-CLI-SOL	88	250	400	195
37	IP00	FRN0085E2E-4E-CLI-SOL	75	IP20	FRN0115E2S-2GB-CLI-SOL	115	IP20	FRN0115E2S-2GB-CLI-SOL	115	250/250	400/400	195/195
45	IP00	FRN0105E2E-4E-CLI-SOL	91							326.2	550	261
55	IP00	FRN0139E2E-4E-CLI-SOL	112							326.2	550	261
75	IP00	FRN0168E2E-4E-CLI-SOL	150							361.2	615	276
90	IP00	FRN0203E2E-4E-CLI-SOL	176							361.2	615	276
110	IP00	FRN0240E2E-4E-CLI-SOL	210							536.4	740	321
132	IP00	FRN0290E2E-4E-CLI-SOL	253							536.4	740	321
160	IP00	FRN0361E2E-4E-CLI-SOL	304							536.4	1000	366
200	IP00	FRN0415E2E-4E-CLI-SOL	377							536.4	1000	366
220	IP00	FRN0520E2E-4E-CLI-SOL	415							686.4	1000	366
280	IP00	FRN0590E2E-4E-CLI-SOL	520							686.4	1000	366

*2HND Overload capability: 120% for 1 min at 50°C

[A] =Current

Contacts

European Headquarters (Germany)
Fuji Electric Europe GmbH
Goethering 58
63067 Offenbach/Main
Tel.: +49 69 669029 0
info.inverter@fujielctric-europe.com
www.fujielctric-europe.com

France
Fuji Electric Europe GmbH
265 Rue Denis Papin
38090 Villefontaine
Tel.: +33 4 74 90 91 24
info.france@fujielctric-europe.com

Spain
Fuji Electric Europe GmbH
C/ Paletes 8, Edifici B, Planta 1, Oficina B
Parc Tecnològic del Vallès
08290 Cerdanyola del Vallès (Barcelona)
Tel.: +34 93 5824333
info.spain@fujielctric-europe.com

United Kingdom
Fuji Electric Europe GmbH
Tel.: +44 7 989 090 783
info.uk@fujielctric-europe.com

Italy
Fuji Electric Europe GmbH
Via Rizzotto 46
41126 Modena (MO)
Tel.: +39 059 4734266
info.italy@fujielctric-europe.com

Switzerland
Fuji Electric Europe GmbH
Park Altenrhein
9423 Altenrhein
Tel.: +41 71 85829 49
info.swiss@fujielctric-europe.com

Global Headquarters (Japan)
Fuji Electric Co., Ltd.
Gate City Ohsaki East Tower
11-2 Osaki 1-chome, Shinagawa-ku,
Tokio 141-0032
Japan
Tel.: +81 3 5435 7058
www.fujielctric.com

High Performance Inverter
FRENIC-Ace

Solar Pumping

Instruction Manual

⚠ CAUTION

Thank you for purchasing our multifunction FRENIC-Ace series of inverters.

- This product is designed to drive a three-phase motor under variable speed control. Read through this user's manual and become familiar with the handling procedure for correct use.
- Improper handling might result in incorrect operation, a short life, or even a failure of this product as well as the motor.
- Deliver this manual to the end user of this product. Keep this manual in a safe place until this product is discarded.
- For how to use an optional device, refer to the instruction and installation manuals for that optional device.

Copyright © 2014 Fuji Electric Co., Ltd.

All rights reserved.

No part of this publication may be reproduced or copied without prior written permission from Fuji Electric Co., Ltd.

All products and company names mentioned in this manual are trademarks or registered trademarks of their respective holders.

The information contained herein is subject to change without prior notice for improvement.

The purpose of this user's manual is to provide accurate information in handling, setting up and operating of the FRENIC-Ace series of inverters. Please feel free to send your comments regarding any errors or omissions you may have found, or any suggestions you may have for generally improving the manual.

In no event will Fuji Electric Co., Ltd. be liable for any direct or indirect damages resulting from the application of the information in this manual.

Preface

Thank you for purchasing our multifunction FRENIC-Ace series of inverters for Solar Pumping application. This product is designed to drive three-phase induction motors or three-phase permanent magnet synchronous motors under variable speed control.

This manual provides the information on the FRENIC-Ace series of inverters including its operating procedure when used in Solar Pumping application. Before use, carefully read this manual for proper use. Improper handling might result in incorrect operation, a short life, or even a failure of this product as well as the motor.

The table below lists the other materials related to the use of the FRENIC-Ace. Read them in conjunction with this manual if necessary.

Name	Material No.	Description
Catalog	24A1-E-0042	Product scope, features, specifications, external drawings, and options of the product
RS-485 Communication User's Manual	24A7-E-0021*	Overview of functions implemented by using FRENIC-Ace RS-485 communications facility, its communications specifications, Modbus RTU/Fuji general-purpose inverter protocol, function codes and related data formats
User's Manual for China model	24A7-E-0043x	This manual is written in English.
User's Manual for China model.	24A7-C-0043x	This manual is written in simplified Chinese.
User's Manual for Japanese model.	24A7-J-0043x	This manual is written in Japanese.

*Available soon

x Is the index letter that indicates the manual version. Please refer to the latest one.

The materials are subject to change without notice. Be sure to obtain the latest editions for use.

Introduction of FRENIC Ace Solar Pumping

In the Solar Pumping application the inverter drives an electrical motor (pump), while the power is supplied usually from a PV panel. FRENIC Ace Solar Pumping inverter specification is equipped with dedicated functions for the correct operation under these special conditions:

- Solar Panel voltage set point calculation at every start (depending on current irradiance and panel temperature)
- True Maximum Power Point Tracking (MPPT) function
- Detection of sudden changes of conditions (irradiance)
- Stop criteria selectable (frequency and/or power)
- Start criteria by solar panel voltage and time (to limit the number of starts)
- Dry pump detection function
- Water tank maximum level detection function
- Low power detection function
- Two sets of PID gains

Index

Chapter 1 SAFETY PRECAUTIONS

This chapter describes the safety precautions that should be considered during the whole life of the product.

Chapter 2 INSTALLATION AND WIRING

This chapter describes the important points in installing and wiring the inverter.

Chapter 3 OPERATION USING THE KEYPAD

This chapter describes keypad operation of the inverter.

Chapter 4 SET UP PROCEDURE

This chapter describes the set up procedure of FRENIC Ace for Solar Pumping application.

Chapter 5 FUNCTION CODES

This chapter explains the function codes relevant for Solar pumping application. For other parameters not described in this manual please refer to FRENIC Ace User Manual.

Chapter 6 TROUBLESHOOTING

This chapter describes troubleshooting procedures to be followed when the inverter malfunctions or detects an alarm or a light alarm condition. In this chapter, first check whether any alarm code or the "light alarm" indication (*I-a*) is displayed or not, and then proceed to the troubleshooting items.



Chapter 7 SPECIFICATIONS

This chapter describes the power circuit input and output ratings and basic constructive specifications of FRENIC Ace standard model.

Chapter 1 SAFETY PRECAUTIONS

Read this manual thoroughly before proceeding with installation, connections (wiring), operation, or maintenance and inspection. Ensure you have sound knowledge of the device and familiarize yourself with all safety information and precautions before proceeding to operate the inverter.

Safety precautions are classified into the following two categories in this manual.

 WARNING	Failure to heed the information indicated by this symbol may lead to dangerous conditions, possibly resulting in death or serious bodily injuries.
 CAUTION	Failure to heed the information indicated by this symbol may lead to dangerous conditions, possibly resulting in minor or light bodily injuries and/or substantial property damage.

Failure to heed the information contained under the CAUTION title can also result in serious consequences. These safety precautions are of utmost importance and must be observed at all times.

Application

 WARNING
<ul style="list-style-type: none">• The FRENIC-Ace is designed to drive a three-phase induction motor. Do not use it for single-phase motors or for other purposes. Fire or an accident could occur.• The FRENIC-Ace may not be used for a life-support system or other purposes directly related to the human safety.• Though the FRENIC-Ace is manufactured under strict quality control, install safety devices for applications where serious accidents or property damages are foreseen in relation to the failure of it. An accident could occur.

Installation

 WARNING
<ul style="list-style-type: none">• Install the inverter on a base made of metal or other non-flammable material. Otherwise, a fire could occur.• Do not place flammable object nearby. Doing so could cause fire.• Inverters FRN0085E2■-4G or above, whose protective structure is IP00, involve a possibility that a human body may touch the live conductors of the main circuit terminal block. Inverters to which an optional DC reactor is connected also involve the same. Install such inverters in an inaccessible place. Otherwise, electric shock or injuries could occur.

 CAUTION
<ul style="list-style-type: none">• Do not support the inverter by its front cover during transportation. Doing so could cause a drop of the inverter and injuries.• Prevent lint, paper fibers, sawdust, dust, metallic chips, or other foreign materials from getting into the inverter or from accumulating on the heat sink.• When changing the positions of the top and bottom mounting bases, use only the specified screws. Otherwise, a fire or an accident might result.• Do not install or operate an inverter that is damaged or lacking parts. Doing so could cause fire, an accident or injuries.

Wiring

WARNING

- If no zero-phase current (earth leakage current) detective device such as a ground-fault relay is installed in the upstream power supply line, in order to avoid the entire power supply system's shutdown undesirable to factory operation, install a residual-current-operated protective device (RCD)/earth leakage circuit breaker (ELCB) individually to inverters to break the individual inverter power supply lines only.
Otherwise, a fire could occur.
- When wiring the inverter to the power source, insert a recommended molded case circuit breaker (MCCB) or residual-current-operated protective device (RCD)/earth leakage circuit breaker (ELCB) (with overcurrent protection) in the path of each pair of power lines to inverters. Use the recommended devices within the recommended current capacity.
- Use wires in the specified size.
- Tighten terminals with specified torque.
Otherwise, a fire could occur.
- When there is more than one combination of an inverter and motor, do not use a multicore cable for the purpose of handling their wirings together.
- Do not connect a surge killer to the inverter's output (secondary) circuit.
Doing so could cause a fire.
- Be sure to connect an optional DC reactor (DCR) when the capacity of the power supply transformer exceeds 500 kVA and is 10 times or more the inverter rated capacity.
Otherwise, a fire could occur.
- Ground the inverter in compliance with the national or local electric code.
- Be sure to ground the inverter's grounding terminals .
Otherwise, an electric shock or a fire could occur.
- Qualified electricians should carry out wiring.
- Be sure to perform wiring after turning the power OFF.
Otherwise, an electric shock could occur.
- Be sure to perform wiring after installing the inverter unit.
Otherwise, an electric shock or injuries could occur.
- Ensure that the number of input phases and the rated voltage of the product match the number of phases and the voltage of the AC power supply to which the product is to be connected.
Otherwise, a fire or an accident could occur.
- Do not connect the power supply wires to output terminals (U, V, and W).
- When connecting a DC braking resistor (DBR), never connect it to terminals other than terminals P(+) and DB.
Doing so could cause fire or an accident.
- In general, sheaths of the control signal wires are not specifically designed to withstand a high voltage (i.e., reinforced insulation is not applied). Therefore, if a control signal wire comes into direct contact with a live conductor of the main circuit, the insulation of the sheath might break down, which would expose the signal wire to a high voltage of the main circuit. Make sure that the control signal wires will not come into contact with live conductors of the main circuit.
Doing so could cause an accident or an electric shock.

WARNING



- Before changing the switches or touching the control circuit terminal symbol plate, **turn OFF the power and wait at least five minutes for inverters FRN0115E2-2G / FRN0072E2-4G or below, or at least ten minutes for inverters FRN0085E2-4G or above.** Make sure that the LED monitor and charging lamp are turned OFF. Further, make sure, using a multimeter or a similar instrument, that the DC link bus voltage between the terminals P(+) and N(-) has dropped to the safe level (+25 VDC or below).
Otherwise, an electric shock could occur.

CAUTION

- The inverter, motor and wiring generate electric noise. Be careful about malfunction of the nearby sensors and devices. To prevent them from malfunctioning, implement noise control measures.
Otherwise an accident could occur.

Operation

WARNING

- Be sure to mount the front cover before turning the power ON. Do not remove the cover when the inverter power is ON.
Otherwise, an electric shock could occur.
- Do not operate switches with wet hands.
Doing so could cause electric shock.
- If the auto-reset function has been selected, the inverter may automatically restart and drive the motor depending on the cause of tripping. Design the machinery or equipment so that human safety is ensured at the time of restarting.
Otherwise, an accident could occur.
- If the stall prevention function (current limiter), automatic deceleration (anti-regenerative control), or overload prevention control has been selected, the inverter may operate with acceleration/deceleration or frequency different from the commanded ones. Design the machine so that safety is ensured even in such cases.
- The  key on the keypad is effective only when the keypad operation is enabled with function code F02 (= 0, 2 or 3). When the keypad operation is disabled, prepare an emergency stop switch separately for safe operations.
Switching the run command source from keypad (local) to external equipment (remote) by turning ON the "Enable communications link" command **LE** disables the  key. To enable the  key for an emergency stop, select the STOP key priority with function code H96 (= 1 or 3).
- If any of the protective functions have been activated, first remove the cause. Then, after checking that the all run commands are set to OFF, release the alarm. If the alarm is released while any run commands are set to ON, the inverter may supply the power to the motor, running the motor.
Otherwise, an accident could occur.
- If you enable the "Restart mode after momentary power failure" (Function code F14 = 3 to 5), then the inverter automatically restarts running the motor when the power is recovered.
Design the machinery or equipment so that human safety is ensured after restarting.
- If the user configures the function codes wrongly without completely understanding this User's Manual, the motor may rotate with a torque or at a speed not permitted for the machine.
- Starting auto-tuning involves motor rotation. Sufficiently check that motor rotation brings no danger beforehand.
An accident or injuries could occur.
- Even if the inverter has interrupted power to the motor, if the voltage is applied to the main circuit input terminals L1/R, L2/S, L3/T, L1/L and L2/N, voltage may be output to inverter output terminals U, V, and W.
- Even if the motor is stopped due to DC braking or preliminary excitation, voltage is output to inverter output terminals U, V, and W.
An electric shock may occur.
- The inverter can easily accept high-speed operation. When changing the speed setting, carefully check the specifications of motors or equipment beforehand.
Otherwise, injuries could occur.

CAUTION

- Do not touch the heat sink and braking resistor because they become very hot.
Doing so could cause burns.
- The DC brake function of the inverter does not provide any holding mechanism.
Injuries could occur.
- Ensure safety before modifying the function code settings.
Run commands (e.g., "Run forward" **FWD**), stop commands (e.g., "Coast to a stop" **BX**), and frequency change commands can be assigned to digital input terminals. Depending upon the assignment states of those terminals, modifying the function code setting may cause a sudden motor start or an abrupt change in speed.
- When the inverter is controlled with the digital input signals, switching run or frequency command sources with the related terminal commands (e.g., **SS1**, **SS2**, **SS4**, **SS8**, **H_z2/H_z1**, **H_z/PID**, **IVS**, and **LE**) may cause a sudden motor start or an abrupt change in speed.
- Ensure safety before modifying customizable logic related function code settings (U codes and related function codes) or turning ON the "Cancel customizable logic" terminal command **CLC**. Depending upon the settings, such modification or cancellation of the customizable logic may change the operation sequence to cause a sudden motor start or an unexpected motor operation.
An accident or injuries could occur.

Maintenance and inspection, and parts replacement

WARNING

- Before proceeding to the maintenance/inspection jobs, **turn OFF the power and wait at least five minutes for inverters FRN0115E2■-2G / FRN0072E2■-4G or below, or at least ten minutes for inverters FRN0085E2■-4G or above.** Make sure that the LED monitor and charging lamp are turned OFF. Further, make sure, using a multimeter or a similar instrument, that the DC link bus voltage between the terminals P(+) and N(-) has dropped to the safe level (+25 VDC or below).
Otherwise, an electric shock could occur.
- Maintenance, inspection, and parts replacement should be made only by qualified persons.
- Take off the watch, rings and other metallic objects before starting work.
- Use insulated tools.
Otherwise, an electric shock or injuries could occur.
- Never modify the inverter.
Doing so could cause an electric shock or injuries.

Disposal

CAUTION

- Treat the inverter as an industrial waste when disposing of it.
Otherwise injuries could occur.

GENERAL PRECAUTIONS

Drawings in this manual may be illustrated without covers or safety shields for explanation of detail parts. Restore the covers and shields in the original state and observe the description in the manual before starting operation.

Icons

The following icons are used throughout this manual.



This icon indicates information which, if not heeded, can result in the inverter not operating to full efficiency, as well as information concerning incorrect operations and settings which can result in accidents.



This icon indicates information that can be useful when performing certain settings or operations.



This icon indicates a reference to more detailed information.

Chapter 2 INSTALLATION AND WIRING

2.1 Installation

(1) Installation Environment

Please install FRENIC-Ace in locations which meet the conditions specified in “Chapter 1 1.3.1 Usage environment” of the User Manual.

(2) Installation Surface

Please install the inverter on non-combustible matter such as metals. Also, do not mount it upside down or horizontally.

⚠ WARNING
Install on non-combustible matter such as metals.
Risk of fire exists

(3) Surrounding Space

Secure the space shown in Figure 2.1-1 and Table 2.1-1. When enclosing FRENIC-Ace in cabinets, be sure to provide adequate ventilation to the cabinet, as the surrounding temperature may rise. Do not contain it in small enclosures with low heat dissipation capacity.

■ Installation of Multiple Inverters

When installing 2 or more units in the same equipment or cabinet, generally mount them to the side of each other, not above each other. When the inverters are mounted above each other, attach partitioning boards to prevent that the heat dissipated from the lower inverter affects the upper inverter.

For types FRN0072E2-4G, FRN0220E2-2G or below and for ambient temperature below 40°C only, the units can be installed side by side without any spacing between them (30°C or lower for ND and HD).

Table 2.1-1 Surrounding Space mm (inch)

Applicable Capacity	A	B	C
200 V class: FRN0001 to 0220E2-2G 200 V class: FRN0001 to 0012E2-7G 400 V class: FRN0002 to 0072E2-4G	10 (0.39)	100 (3.9)	0 *1
400 V class: FRN0085 to 0590E2-4G	50 (1.97)		100 (3.9)

*1 A clearance of 50 mm is required to use RJ45 connector.

C: Space in front of the inverter unit



Figure 2.1-1 Installation Direction

■ Installation with External Cooling

The external cooling installation reduces the generated heat inside the panel by dissipating approximately 70% of the total heat generated (total heat loss) by mounting the cooling fins protruding outside the equipment or cabinet.

Installation with external cooling is possible for types FRN0069E2-2G and FRN0072E2-4G or below by adding attachments (optional) for external cooling, and for types FRN0085E2-4G or above by moving the mounting bases.

Please refer to User Manual Chapter 11 Item 11.15 for the external dimensions drawing of the external cooling attachment (optional).

⚠ CAUTION
Prevent lint, wastepaper, wood shavings, dust, metal scrap, and other foreign material from entering the inverter or from attaching to the cooling fins.
Risk of fire and risk of accidents exist

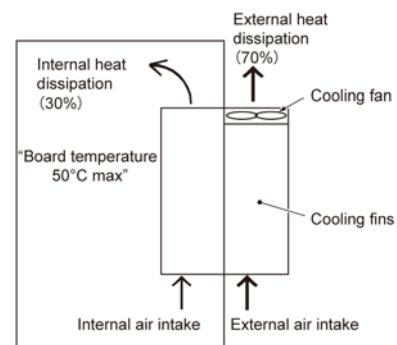

Figure 2.1-2 Installation with External Cooling

To install the FRN0085E2-4G inverter with external cooling, change the mounting position of the mounting bases following the procedure in Figure 2.1-3.

As the type and number of screws differ by inverter type, please review the following table.

Table 2.1-2 Type and Number of Screws, and Tightening Torque

Inverter type	Mounting base fixation screw	Case attachment screw	Tightening torque N·m (lb-in)
FRN0085E2■-4G to FRN0168E2■-4G	M6×20 (5 screws on top, 3 screws on bottom)	M6×20 (2 screws on top only)	5.8 (51.3)
FRN0203E2■-4G	M6×20 (3 screws on top and bottom each)	M6×12 (3 screws on top only)	5.8 (51.3)
FRN0240E2■-4G to FRN0290E2■-4G	M5×12 (7 screws on top and bottom each)	M5×12 (7 screws on top only)	3.5 (31.0)
FRN0361E2■-4G to FRN0415E2■-4G	M5×16 (7 screws on top and bottom each)	M5×16 (7 screws on top only)	3.5 (31.0)
FRN0520E2■-4G to FRN0590E2■-4G	M5×16 (8 screws on top and bottom each)	M5×16 (8 screws on top only)	3.5 (31.0)

- 1) Remove all of the mounting base fixation screws and the case attachment screws on the top of the inverter.
- 2) Fix the mounting bases to the case attachment screw holes using the mounting base fixation screws. A few screws should remain after changing the position of the mounting bases.
- 3) Change the position of the mounting bases on the bottom side following the procedure in 1) and 2).

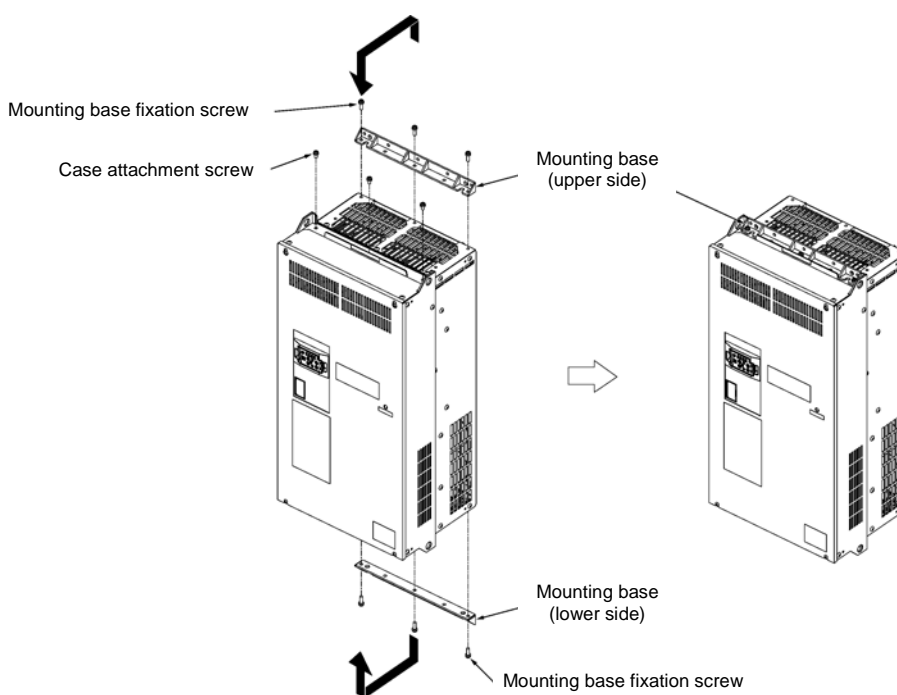

Figure 2.1-3 Method to Change the Mounting Base Positions

CAUTION
Use the specified screws in changing the mounting bases. Risk of fire and risk of accidents exist

Inverter unit installation screw size.

Select the bolt size, considering the thickness of the mounting feet and installation surface so that the bolt protrudes from the nut by 2 threads or more.

Inverter type	Inverter fixation screw	Tightening torque N·m (lb-in)
200V class : FRN0030/0040E2■-2G 400V class : FRN0022/0029E2■-4G	M5 (4 screws)	3.5 (31.0)
200V class : FRN0056/0069E2■-2G 400V class : FRN0037E2■-4G to RN0203E2■-4G	M8 (4 screws)	13.5 (119)
400V class : FRN0240E2■-4G to RN0415E2■-4G	M12 (4 screws)	48 (425)
400V class : FRN0520E2■-4G to RN0590E2■-4G	M12 (6 screws)	48(425)

2.2 Wiring

This chapter describes the basic connection diagram alternatives for Solar Pumping application.

2.2.1 Input and output control signals.

Table 2.2-1 describes the input control signals to the inverter.

Table 2.2-1 Input control signals to the inverter.

INPUT	DESCRIPTION	SYMBOL
[12]	Water tank level analog signal. The signal from the water level sensor of the tank can be connected to this input. The inverter will stop when the tank level becomes higher than the level programmed in parameter U128. In order to use this signal, connect the sensor to this input and set the desired tank level above which the pump has to stop. If this signal is not used, set a high level in parameter U128 to avoid that the inverter stops.	TANK LEVEL
[FWD]	Run command in the FWD direction	FWD
[REV]	Run command in the REV direction	REV
[X1]	Water tank high level digital signal. This signal is ON when the level of the tank is high. The inverter will stop when this signal is ON. In order to use this signal, simply connect it to the inverter; it is not required to enable it by function code.	TANK HL

Table 2.2-2 describes the output control signals from the inverter. The assignment of the outputs can be changed if required. To do so, change the settings of parameters E20, E21, E27.

Table 2.2-2 Output control signals from the inverter.

OUTPUT	DESCRIPTION	SYMBOL
[Y1]	Tank full output signal. This signal indicates that the water tank is full. In this situation the inverter will not be allowed to RUN, therefore this signal is useful to indicate/diagnose the cause of the stop.	TANK FULL
[Y2]	Low power output signal. This signal indicates that the output power is low. In case that this signal is ON and the solar irradiance is high, it is useful to detect/diagnose that there is a problem in the PV solar panel (for example dust, or the panel has been covered).	LOW POWER
[30A/B/C]	This relay output is used to indicate that the inverter has tripped by alarm. The alarm code is displayed in the inverter keypad.	ALM

2.2.2 Inverter supplied from PV panel only

There are two alternatives of connecting the PV panel to the inverter:

- (1) Connected to the DC bus terminals P(+), N(-). In this case the precharging circuit of the inverter is not used. Therefore, when the PV panel is connected to the inverter, high current may flow through at the initial stage because the inverter DC link capacitor is discharged. In order to avoid the high charging current, there are some alternatives:
 - o do not make the connection when the PV panel is already receiving strong irradiation, or
 - o insert a pre-charging circuit in the connection between (+) (PV panel positive pole) and P(+), or
 - o use the connection alternative (2) described in following pages.

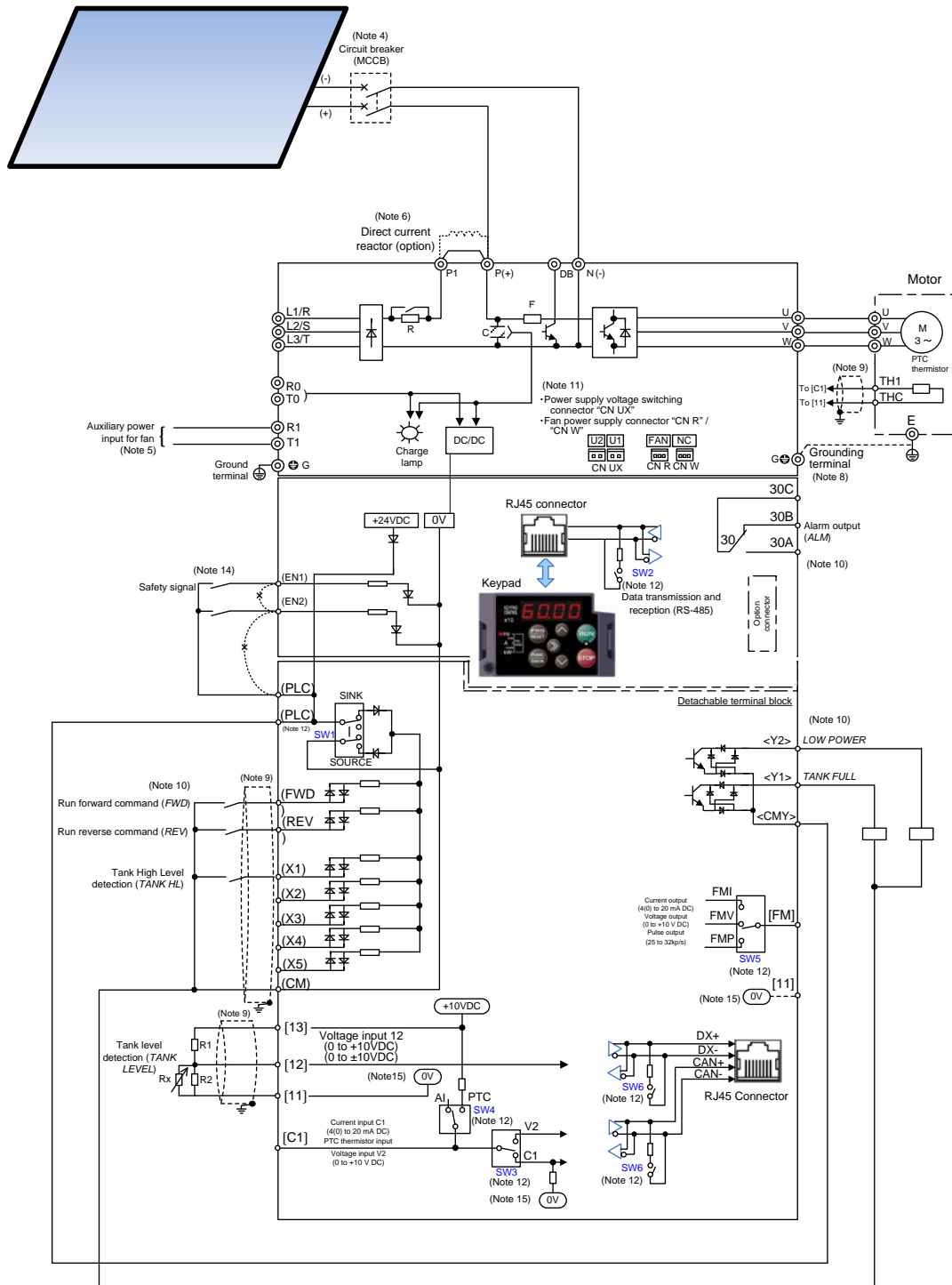

Figure 2.2-1 Wiring diagram when inverter is supplied from PV panel connected to DC bus terminals.

When using this wiring please ensure that the motor is not regenerating. In case of regeneration the DC link voltage of the inverter will rise damaging the PV panels. In order to avoid regeneration when operation command is removed please set function code H11=1 (Coast to a stop). If regeneration cannot be avoided (for example, controlled deceleration is always required), please use connection alternative (2) below.

- (2) Connected to the AC supply inputs and N(-). In this case the precharging circuit of the inverter is used, limiting the initial charging current of the inverter DC link capacitor. In this case be aware that the maximum frequency of charging cycles is two times per hour. When using this connection the current rating of the input rectifier must be considered. Please consult Fuji Electric to make the inverter selection.

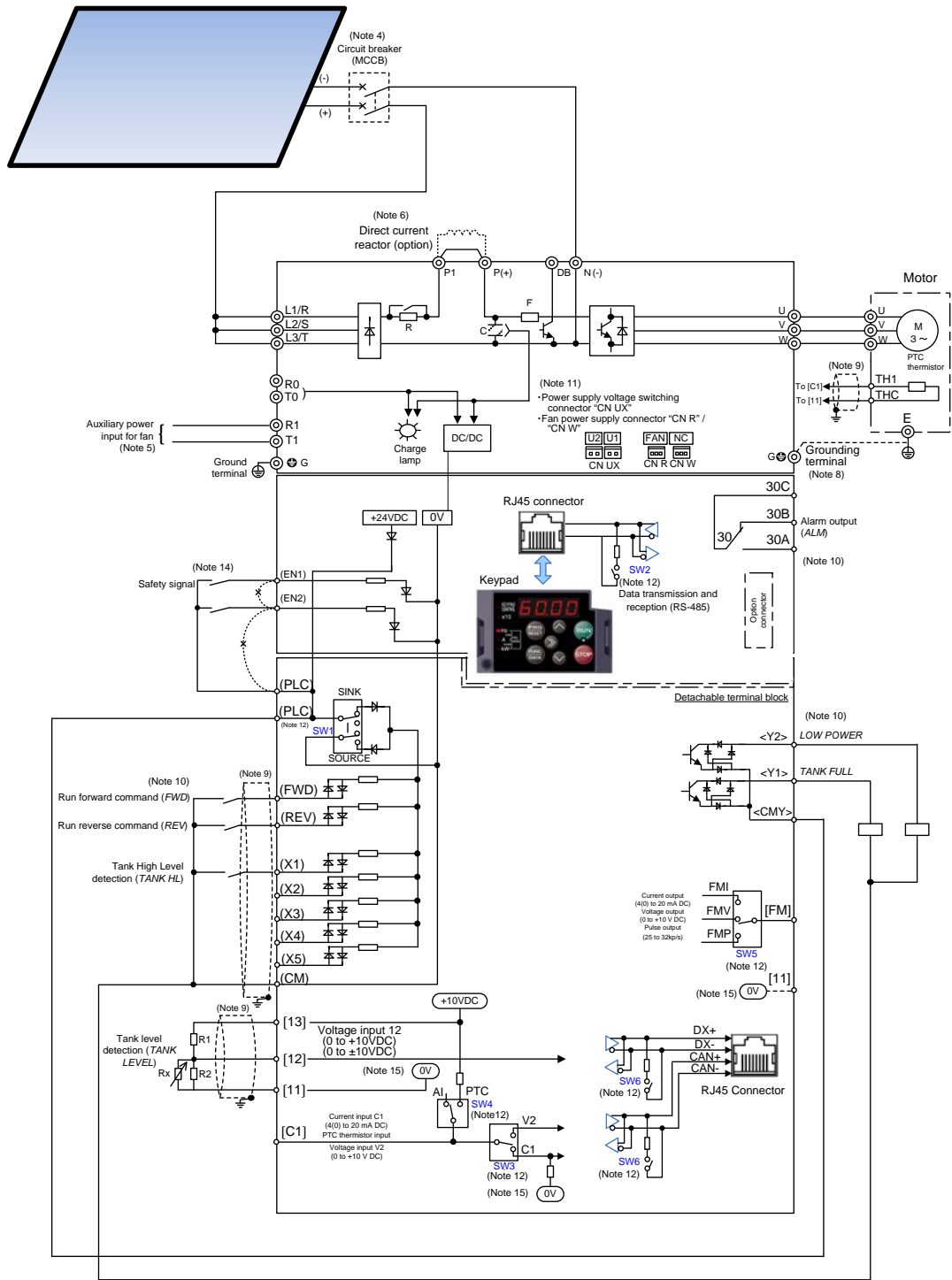

Figure 2.2-2 Wiring diagram when inverter is supplied from PV panel connected to AC input and N(-) terminals.

2.2.3 Inverter supplied from PV panel and AC supply

When the inverter can be supplied from PV panel and AC supply at the same time, as shown in figure 2.2-4, please insert magnetic contactors in both PV panel supply and AC supply and make the necessary interlock to avoid that both supplies are connected at the same time. Additionally to the magnetic contactors, insert blocking diodes with the suitable rating between the PV panel and the inverter.

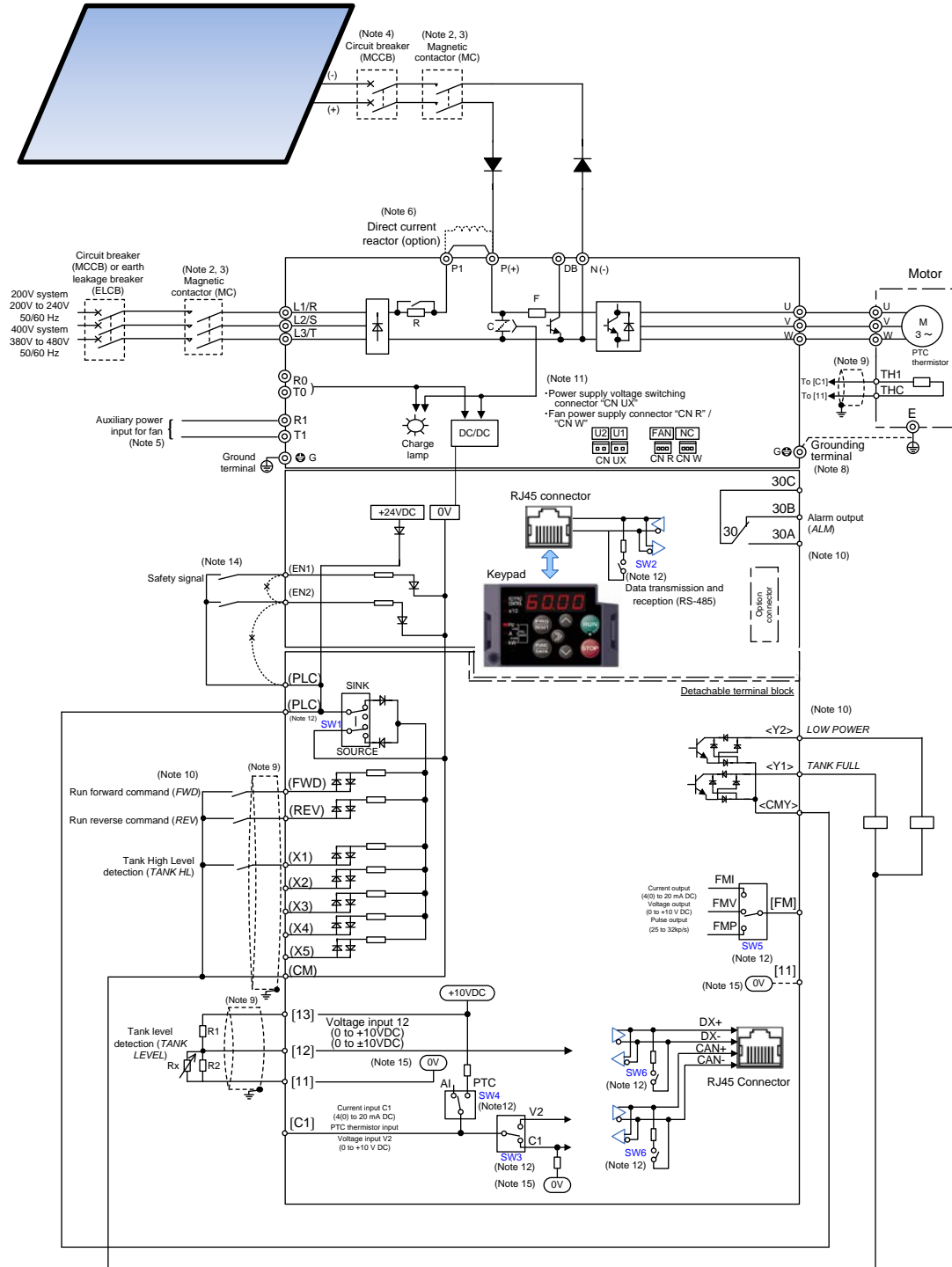



Figure 2.2-3 Wiring diagram when inverter is supplied from PV panel and AC supply.

⚠ CAUTION

- The PV panel is a DC voltage/current source. Therefore in all cases please ensure that the polarity is respected when performing the connection between the inverter and the PV panel, otherwise either equipment may be damaged

Risk of fire and risk of damage exist.

Notes for all drawings:

- (Note 1) Install recommended circuit breakers (MCCB) or residual-current-operated protective device (RCD)/ earth leakage breakers (ELCB) (with overcurrent protective function) on the inputs of each inverter (primary side) for wiring protection. Do not use breakers which exceed the recommended rated current.
- (Note 2) Install recommended magnetic contactors (MC) as necessary on each inverter as these will be used to disconnect the inverter from the power supply separately from the MCCB or the RCD / ELCB. Additionally, when installing coils such as MC or solenoid close to the inverter, connect surge absorbers in parallel.
- (Note 3) Make the necessary interlock to avoid that both PV panel supply and AC supply are connected at the same time. Not preventing this may cause damage to the equipment.
- (Note 4) Used for the protection of the PV panel and the wiring. Alternatively fuses can be also used. Please use recommended types by the PV panel maker. The use of additional protection devices (like surge protection devices) may be also recommended by the PV panel maker.
- (Note 5) Use this terminal when supplying the inverter with DC voltage from the PV panel. Applicable for types FRN0203E2■-4G or above. Please consult Fuji Electric.
- (Note 6) Remove the shorting bar between the inverter main circuit terminals P1-P(+) before connecting the direct current reactor (DCR) (option).
It must be connected in the following cases:
ND mode: Types FRN0139 E2■-4G or above, HD/ HND mode: Types FRN0168E2■-4G or above, HHD mode: Types FRN0203E2■-4G or above.
Use the direct current reactor (option) when the power supply transformer capacity is above 500 kVA and the transformer capacity is over 10 times the rated capacity of the inverter, or when "thyristor load exists" in the same power system. In case of PV panel supply only, DCR is not required for any capacity.
- (Note 8) This terminal is used for grounding the motor. Grounding the motor using this terminal is recommended in order to suppress inverter noise.
- (Note 9) Use twisted lines or shielded lines for the control signals.
Generally, the shielded line requires grounding, but when the effect of externally induced noise is large, connecting to [CM] may suppress the effect of noise. Separate the line from the main circuit wiring and do not enclose in the same duct. Separation distance of over 10 cm is recommended. When crossing the main circuit wiring, make the intersection perpendicular.
- (Note 10) The various functions listed for terminals [X1] to [X5] (digital inputs), terminals [Y1] to [Y2] (transistor outputs), and terminal [FM] (monitor output) show the recommended functions for Solar Pumping application.
- (Note 11) These are connectors for switching the main circuit. For details, refer to "2.2.7 Switching connectors".
- (Note 12) The various switches on the control printed circuit board define the settings for the inverter operation. For details, refer to "2.2.6 Operating slide switches".
- (Note 14) Shorting bars are connected between the safety function terminals [EN1], [EN2], and [PLC] as factory default. Remove the shorting bars when using this function.
- (Note 15)  and  are separated and insulated.
- (Note 16) Charge lamp does not exist in the inverters FRN0069E2■-2G/FRN0044E2■-4G/FRN0012E2■-7G or below.

2.2.4 Removal and attachment of the front cover/terminal cover and wiring guide

⚠ CAUTION

Always remove the RS-485 communication cable from the RJ-45 connector before removing the front cover.
Risk of fire and risk of accidents exist.

(1) Types FRN0020E2■-2□/ FRN0012E2■-4□/ FRN0011E2■-7□ or below

- 1) Loosen the screws of the terminal cover. To remove the terminal cover, put your finger in the dimple of the terminal cover and then pull it up toward you.
- 2) Pull out the wiring guide toward you.
- 3) After routing the wires, attach the wiring guide and the terminal cover reversing the steps above.

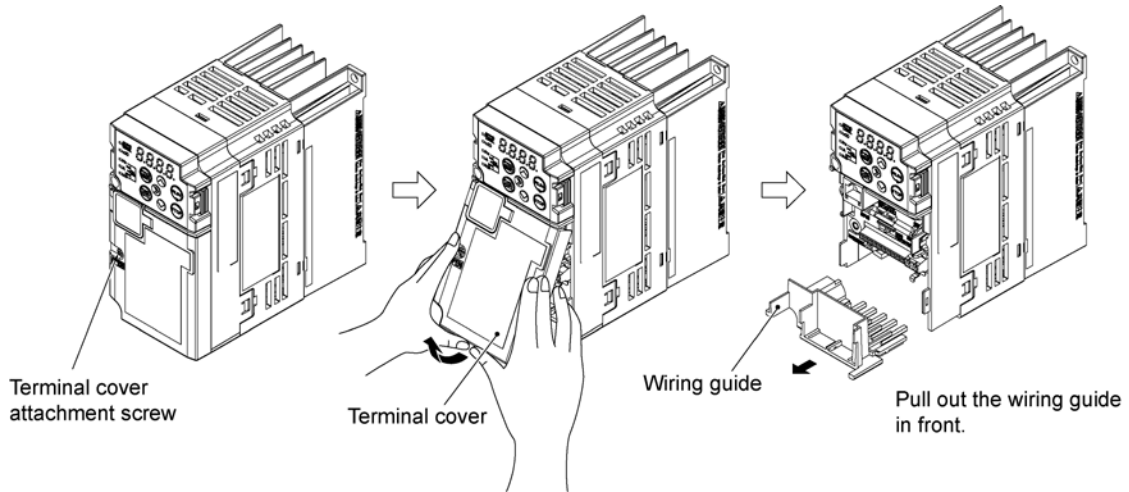

Figure 2.2-1 Removal of the Terminal Cover and the Wiring Guide (for FRN0006E2S-2□)

(2) Types FRN0030E2■-2□ to FRN0069E2■-2□ and FRN0022E2■-4□ to FRN0044 E2■-4□

- 1) Loosen the screws of the terminal cover. To remove the terminal cover, put your finger in the dimple of the terminal cover and then pull it up toward you.
- 2) Pull out the wiring guide toward you.
- 3) After routing the wires, attach the wiring guide and the terminal cover reversing the steps above.

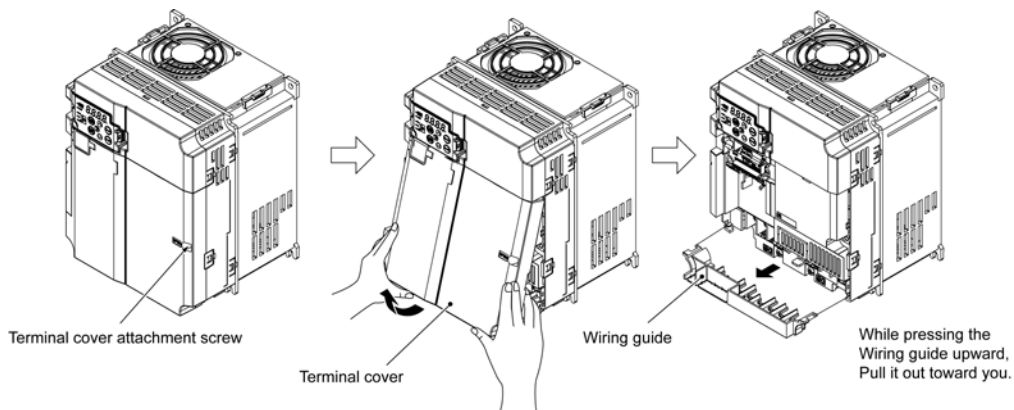

Figure 2.2-2 Removal of the Terminal Cover and the Wiring Guide (for FRN0069E2■-2□)

(3) Types FRN0088E2-2□/ FRN0115E2-2□/ FRN0072E2-4□/ FRN0085E2-4□

- 1) Loosen the screws of the front cover. Hold both sides of the front cover with the hands, slide the cover downward, and pull. Then remove it to the upward direction.
- 2) Push the wiring guide upward and pull. Let the wiring guide slide and remove it.
- 3) After routing the wires, attach the wiring guide and the front cover reversing the steps above.

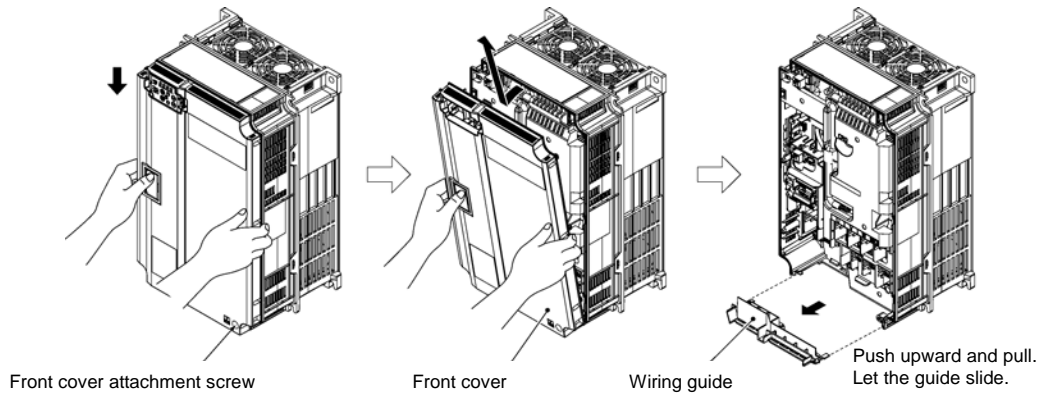
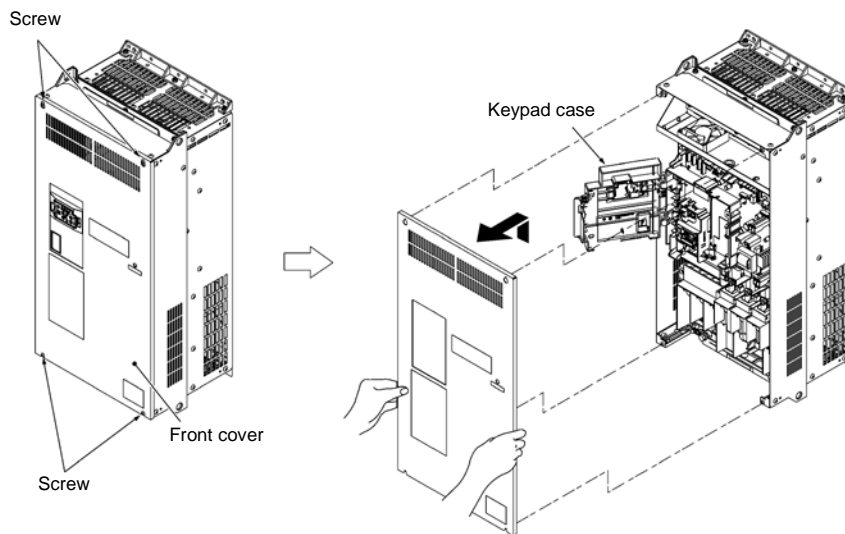

Figure 2.2-3 Removal of the Front Cover and the Wiring Guide (for FRN0072E2-4□)

(4) Types FRN0085E2-4□ or above

- 1) Loosen the screws of the front cover. Hold both sides of the front cover with the hands and slide it upward to remove.
- 2) After routing the wires, align the front cover top edge to the screw holes and attach the cover reversing the steps in Figure 2.2-4.

Tip Open the keypad case to view the control printed circuit board.



Tightening torque: 1.8 N·m(15.9 lb-in) (M4)
3.5 N·m(31.0 lb-in) (M5)

Figure 2.2-4 Removal of the front cover (for FRN0203E2-4□)

2.2.5 Main circuit terminals

Terminal layout diagram (main circuit terminals)

Figure A

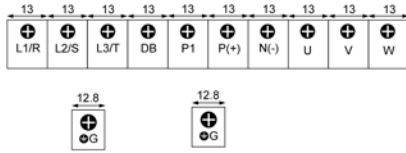

Figure B

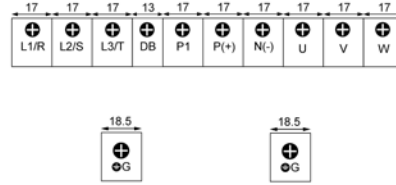

Figure C

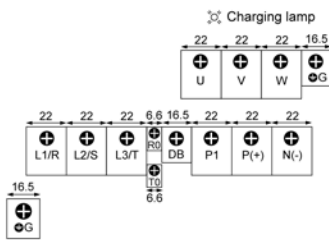

Figure D

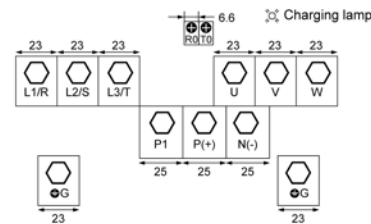

Figure E / Figure F

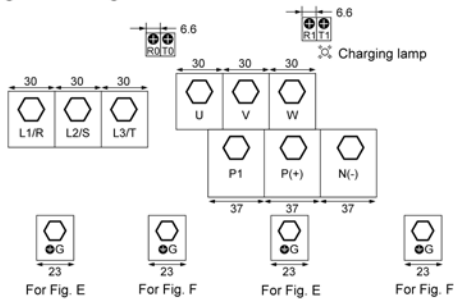

Figure G / Figure H

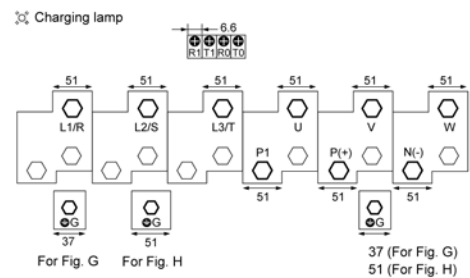

Figure 2.2-7 Main circuit terminals layout

⚠ WARNING ⚠

The following terminals will have high voltage when power is ON.

Main circuit: L1/R, L2/S, L3/T, P1, P(+), N(-), DB, U, V, W, R0, T0, R1, T1

Insulation level

Main circuit - Casing : Basic insulation (overvoltage category III, degree of contamination 2)

Main circuit - Control circuit : Enhanced insulation (overvoltage category III, degree of contamination 2)

Risk of electric shock exists

For recommended wire sizes please refer to the User Manual.

[1] Description of terminal functions (main circuit terminal)

Classification	Terminal symbol	Terminal name	Specification
Main circuit	L1/R, L2/S, L3/T	Main power input	Terminals to connect three-phase power source.
	L1/L, L2/N	Main power input	Terminals to connect single-phase power source.
	U, V, W	Inverter output	Terminals to connect three-phase motors.
	P (+), P1	For direct current reactor connection	Terminals to connect DC reactor (DCR) for power factor enhancement. It must be connected in the following cases: ND mode: Types FRN0139E2■-4G or above. HD/HND mode: Types FRN0168E2■-4G or above. HHD mode: Types FRN0203E2■-4G or above. It is not required to connect a DC reactor when supplying the inverter only from PV panel.
	P (+), N (-)	For direct current bus connection	Terminals to connect to DC supply voltage from PV panel.
	P (+), DB	For braking resistor connection	Terminals to connect a braking resistor (optional). Wiring length: Below 5 meters. (Types FRN0220E2■-2G/FRN0072E2■-4G or below)
	 G	For inverter chassis (case) grounding	Grounding terminal for inverter chassis (case).
	R0, T0	Auxiliary power input for control circuit	When it is desired to retain the alarm signal for the activation of the protective function at even inverter main power supply shut off or when continuous display of the keypad is desired, connect this terminal to the power supply. (Types FRN0185E2■-2G/FRN0059E2■-4G or above)
	R1, T1	Auxiliary power input for fan	Ordinarily, these terminals do not need to be connected. Connect these terminals to AC power supply when operating with direct current power input (such as in combination with PWM converters). (Types FRN0203E2■-4G or above)

Follow the sequence below when wiring.

- (1) Inverter ground terminal (zG)
- (2) Inverter output terminals (U, V, W), motor ground terminal (zG)
- (3) Direct current reactor connection terminals (P1, P(+))*
- (4) Braking resistor connection terminals (P(+), DB)*
- (5) Direct current bus connection terminals (P(+), N(-))*
- (6) Main power supply input terminals (L1/R, L2/S, L3/T) or (L1/L, L2/N)

* Connect if necessary

2.2.5 Control circuit terminals (common to all models)

[2] Terminal layout diagram (control circuit terminals)

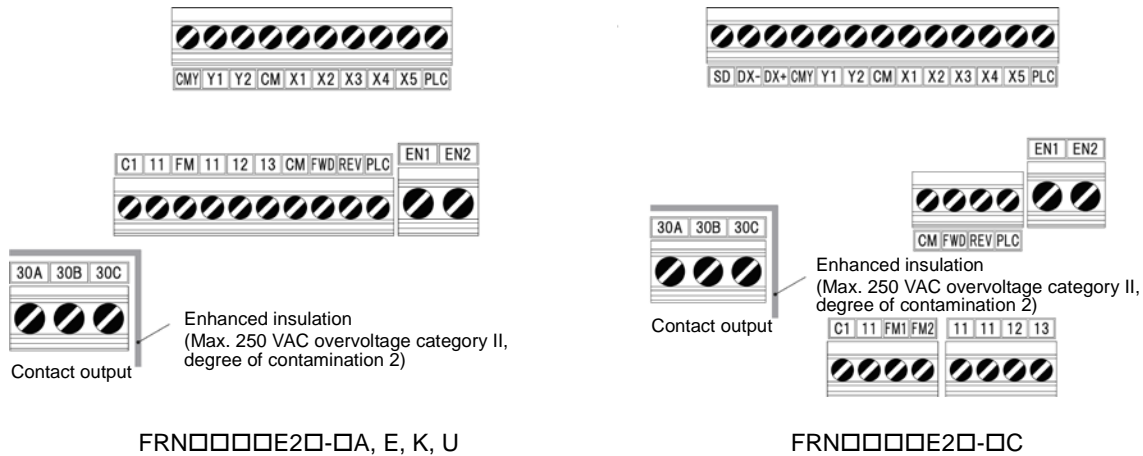

Figure 2.2-8 Control circuit terminals layout

⚠ WARNING ⚠

The following terminals will have high voltage when the power is ON.
 Control terminals: AUX-contact (30A, 30B, 30C, Y5A, Y5C)
 Insulation level
 Contact output – control circuit : Enhanced insulation (overvoltage category II, degree of contamination 2)
Risk of electric shock exists

[3] Description of terminal functions (control circuit terminal)

Table 2.2.6-3 Functional Description of Control Circuit Terminals (continued)

Classification	Terminal symbol	Terminal name	Functional description																			
Digital input	[EN1] [EN2]	Enable input	<p>(1) When terminals [EN1]-[PLC] or terminals [EN2]-[PLC] are OFF, the inverter output transistors stop functioning. (Safe Torque Off: STO) Be sure to operate terminals [EN1] and [EN2] simultaneously; otherwise an <i>ecf</i> alarm is issued and the operation of the inverter will be disabled. To enable the Enable function, remove the short bar.</p> <p>(2) The input mode for terminals [EN1] and [EN2] is fixed to source. The mode cannot be switched to sink.</p> <p>(3) Short-circuit terminals [EN1]-[PLC] and [EN2]-[PLC] with short bars when the Enable input function is not used. (Keep the short bar connected).</p> <p><EN terminal circuit specification></p> <table border="1" style="margin-left: auto; margin-right: auto;"> <thead> <tr> <th colspan="2">Item</th> <th>Min.</th> <th>Max.</th> </tr> </thead> <tbody> <tr> <td rowspan="2">Operating voltage (SOURCE)</td> <td>ON level</td> <td>22 V</td> <td>27 V</td> </tr> <tr> <td>OFF level</td> <td>0 V</td> <td>2 V</td> </tr> <tr> <td colspan="2">Operating current at ON (at input voltage 24 V)</td> <td>-</td> <td>4.5 mA</td> </tr> <tr> <td colspan="2">Allowable leak current at OFF</td> <td>-</td> <td>0.5 mA</td> </tr> </tbody> </table>	Item		Min.	Max.	Operating voltage (SOURCE)	ON level	22 V	27 V	OFF level	0 V	2 V	Operating current at ON (at input voltage 24 V)		-	4.5 mA	Allowable leak current at OFF		-	0.5 mA
	Item		Min.	Max.																		
Operating voltage (SOURCE)	ON level	22 V	27 V																			
	OFF level	0 V	2 V																			
Operating current at ON (at input voltage 24 V)		-	4.5 mA																			
Allowable leak current at OFF		-	0.5 mA																			
	[PLC]	Programmable controller signal power source	<p>(1) The terminal is used for connecting the output signal power source of the programmable controller (rated voltage DC +24 V (power supply voltage fluctuation range: DC +22 to +27 V) maximum 100 mA).</p> <p>(2) The terminal can also be used for the power source for the load connected to the transistor output. For details, refer to the page on transistor output.</p>																			

Table 2.2.6-3 Functional Description of Control Circuit Terminals (continued)

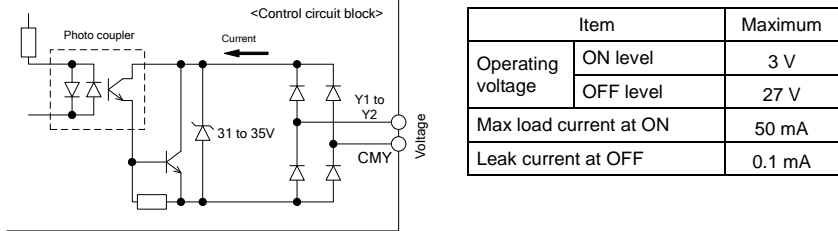
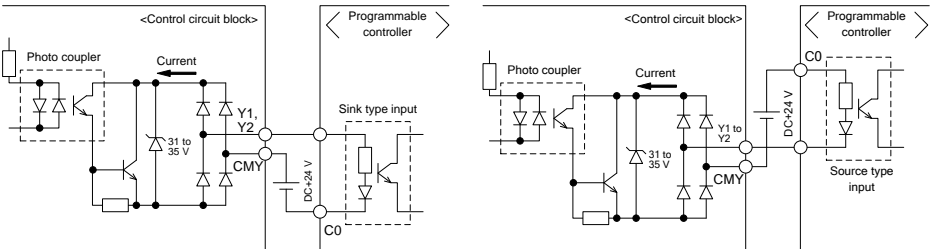
Classification	Terminal symbol	Terminal name	Functional description														
Transistor output	[Y1]	Transistor output 1	<p>(1) Various signals (running signal, frequency reached signal, overload forecast signal, etc) set up by function code E20, E21 can be output. For details, refer to "Chapter 5 Function Codes".</p> <p>(2) The operating mode between transistor output terminals [Y1], [Y2] and terminal CMY can be switched to "ON (active ON) at signal output" or "OFF (active OFF) at signal output".</p> <p><Transistor output circuit specification></p>  <table border="1" data-bbox="991 562 1364 730"> <thead> <tr> <th colspan="2">Item</th> <th>Maximum</th> </tr> </thead> <tbody> <tr> <td rowspan="2">Operating voltage</td> <td>ON level</td> <td>3 V</td> </tr> <tr> <td>OFF level</td> <td>27 V</td> </tr> <tr> <td colspan="2">Max load current at ON</td> <td>50 mA</td> </tr> <tr> <td colspan="2">Leak current at OFF</td> <td>0.1 mA</td> </tr> </tbody> </table> <p style="text-align: center;">Figure 2.2-14 Transistor Output Circuit</p> <p>Note</p> <ul style="list-style-type: none"> Connect surge absorbing diode on both ends of the excitation coil when connecting control relays. When a power source is needed for the circuit to be connected, terminal PLC can be used as a power source terminal (DC24 V (power supply voltage fluctuation range: DC22 to 27 V), maximum 50 mA). In this case, terminal [CMY] must be shorted to terminal [CM]. <p>SW8 switches the [Y2] terminal output between a general-purpose output assigned by function code E21 and a functional safety circuit failure output SRCF. The factory default of SW8 is a general-purpose output.</p> <p>When SRCF is assigned to terminal [Y2]: if terminal [Y2] is ON, it means "No ecf alarm." if terminal [Y2] is OFF, it means "ecf alarm has occurred."</p> <p>Note that when SRCF is assigned, the operating mode between terminals [Y2] and [CMY] is fixed at "active ON" (ON at signal output).</p> <p>For details about an ecf alarm, refer to Section 6.3.2 "Causes, checks and measures of alarms."</p>	Item		Maximum	Operating voltage	ON level	3 V	OFF level	27 V	Max load current at ON		50 mA	Leak current at OFF		0.1 mA
	Item			Maximum													
	Operating voltage	ON level	3 V														
OFF level		27 V															
Max load current at ON		50 mA															
Leak current at OFF		0.1 mA															
[Y2]	Transistor output 2																
[CMY]	Transistor output common	<p>This terminal is the common terminal for transistor output signals.</p> <p>This terminal is insulated against terminals [CM] and [11].</p>															
<p>Tip ■ When connecting the programmable controller to terminals [Y1], [Y2].</p> <p>The circuit configuration example for connecting the inverter transistor output to the programmable controller is shown in Figure 2.2-15. Circuit (a) in Figure 2.2-15 shows the programmable controller input circuit as sink input and circuit (b) shows as the source input case.</p>			 <p>(a) Connection diagram for sink input type programmable controller</p> <p>(b) Connection diagram for source input type programmable controller</p> <p style="text-align: center;">Figure 2.2-15 Example of Connection Circuit Configuration with Programmable Controller</p>														

2.2.6 Operating slide switches

⚠ WARNING ⚠

Operation of the various switches should be conducted **after more than 5 minutes has elapsed** since power is shut off for types smaller than FRN0069E2-2□ and FRN0072E2-4□ and **after more than 10 minutes has elapsed for types larger than FRN0085E2-4□**. Confirm that the LED monitor and the charge lamp are turned off, and that the direct current intermediate circuit voltage between the main circuit terminals P(+) - N(-) is below the safe voltage (below DC+25 V) with the tester before operating the switches.

Risk of electric shock exists.

The I/O terminal specification can be changed, such as switching the analog output form, by operating the various slide switches on the printed circuit board (Figure 2.2-22 Slide Switches Positions on the Control Printed Circuit Board).

To operate the various slide switches, remove the front cover and make the control printed circuit board visible. (For types larger than FRN0085E2-4□, also open the keypad case).

Refer to Section 2.2.2 "Removal and attachment of the front cover and wiring guide" to remove the front cover and to open/close the keypad case.

The slide switches positions on the control printed circuit board are shown below.

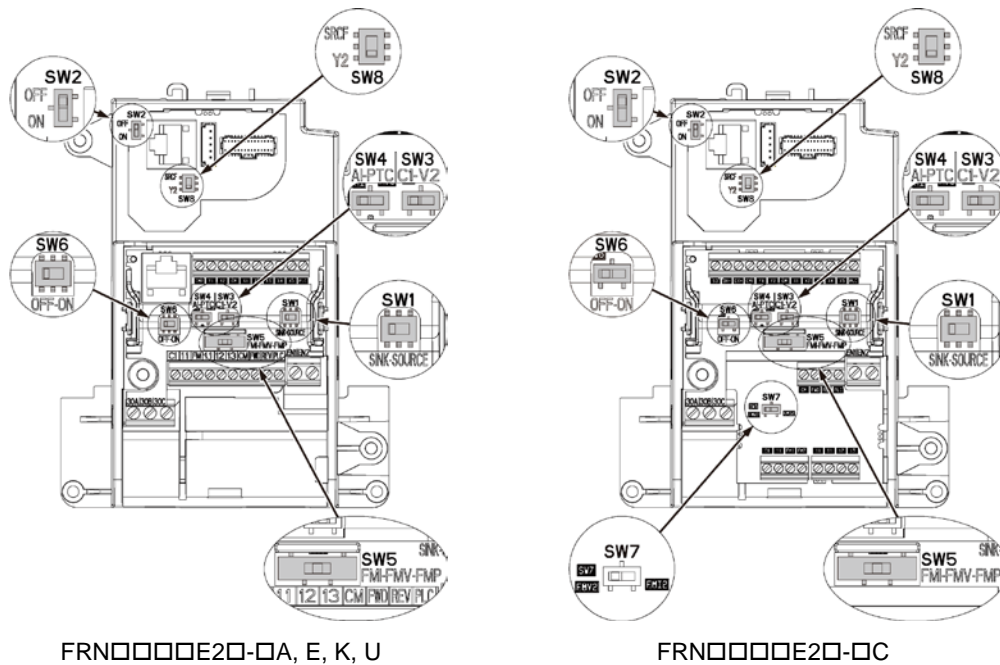

Figure 2.2-9 Slide Switches Locations on the Control Printed Circuit Board

	SW1	SW2	SW3	SW4	SW5	SW6	SW7 only on FRN□□□□ E2□-□C	SW8
Factory default FRN□□□□E2□-□E	SOURCE	OFF	C1	A1	FMV	OFF	—	Y2
Factory default FRN□□□□E2□-□A, C, K, U	SINK	OFF	C1	A1	FMV	OFF	FMV2	Y2
—	SOURCE	ON	V2	PTC	FMI FMP	ON	FMI2	SRCF

Note Use pointed devices (such as tweezers) to operate the switches. Avoid touching other electronic parts when moving the switches. The switch will be at open state when the slider is in the middle, so make sure to push the slider to the ends.

Functional description of the slide switches is given in Table 2.2.8-1 "Functional Description of Various Switches."

Table 2.2.8-1 Functional Description of Slide Switches

Switch symbol	Functional description																				
SW1	<p><Switch to change sink/source setting of digital input terminals></p> <ul style="list-style-type: none"> This switch determines the type of input (sink or source) to use for digital input terminals [X1] to [X5], FWD, and REV. 																				
SW2	<p><Switch to change the RS-485 communication terminating resistor (RS-485 communication port (on the control PCB))></p> <ul style="list-style-type: none"> Move to the ON side when RS-485 communication is used and this inverter is connected to the termination. 																				
SW3 SW4	<p><Switch to change terminal [C1] input setting to current/voltage/PTC thermistor> This switch changes the input type for terminal [C1].</p> <table border="1"> <thead> <tr> <th>Input type</th> <th>SW3</th> <th>SW4</th> <th>E59</th> <th>H26</th> </tr> </thead> <tbody> <tr> <td>Current input (factory default)</td> <td>C1 side</td> <td>AI side</td> <td>0</td> <td>0</td> </tr> <tr> <td>Voltage input</td> <td>V2 side</td> <td>AI side</td> <td>1</td> <td>0</td> </tr> <tr> <td>PTC thermistor input</td> <td>C1 side</td> <td>PTC side</td> <td>0</td> <td>1</td> </tr> </tbody> </table>	Input type	SW3	SW4	E59	H26	Current input (factory default)	C1 side	AI side	0	0	Voltage input	V2 side	AI side	1	0	PTC thermistor input	C1 side	PTC side	0	1
Input type	SW3	SW4	E59	H26																	
Current input (factory default)	C1 side	AI side	0	0																	
Voltage input	V2 side	AI side	1	0																	
PTC thermistor input	C1 side	PTC side	0	1																	
SW5	<p><Switch to change terminal [FM] output setting to current/voltage/pulse> This switch changes the output type for terminal [FM]. When operating this switch, also change function code F29.</p> <table border="1"> <thead> <tr> <th>Output type</th> <th>SW5</th> <th>F29</th> </tr> </thead> <tbody> <tr> <td>Current output</td> <td>FMI side</td> <td>1 or 2</td> </tr> <tr> <td>Voltage output (factory default)</td> <td>FMV side</td> <td>0</td> </tr> <tr> <td>Pulse output</td> <td>FMP side</td> <td>3</td> </tr> </tbody> </table>	Output type	SW5	F29	Current output	FMI side	1 or 2	Voltage output (factory default)	FMV side	0	Pulse output	FMP side	3								
Output type	SW5	F29																			
Current output	FMI side	1 or 2																			
Voltage output (factory default)	FMV side	0																			
Pulse output	FMP side	3																			
SW6	<p><Switch to change the RS-485 communication terminating resistor (RS-485 communication port (on the terminal board))></p> <p>FRN□□□□E2□-□A, E, K, U</p> <ul style="list-style-type: none"> Used for the RS-485/CANopen communication. Move the switch to the ON position when the inverter is connected to the terminal. They cannot be used simultaneously. <p>FRN□□□□E2□-□C</p> <ul style="list-style-type: none"> Used for the RS-485 communication. Move the switch to the ON position when the inverter is connected to the termination. 																				
SW7	<p><Switch to change terminal [FM2] output setting to voltage/current> The terminal is used only on the FRN□□□□E2□-□C.</p> <p>This switch changes the output type for terminal [FM2]. When operating this switch, also change function code F32.</p> <table border="1"> <thead> <tr> <th>Output type</th> <th>SW7</th> <th>F32</th> </tr> </thead> <tbody> <tr> <td>Voltage output</td> <td>FMV2 side</td> <td>0</td> </tr> <tr> <td>Current output</td> <td>FMI2 side</td> <td>1 or 2</td> </tr> </tbody> </table>	Output type	SW7	F32	Voltage output	FMV2 side	0	Current output	FMI2 side	1 or 2											
Output type	SW7	F32																			
Voltage output	FMV2 side	0																			
Current output	FMI2 side	1 or 2																			
SW8	<p><Switch to change terminal [FM2] output setting to general-purpose/SRCF> This switch changes the output for terminal [Y2].</p> <table border="1"> <thead> <tr> <th>Output</th> <th>SW8</th> </tr> </thead> <tbody> <tr> <td>General-purpose output</td> <td>Y2 side</td> </tr> <tr> <td>SRCF output</td> <td>SRCF side</td> </tr> </tbody> </table>	Output	SW8	General-purpose output	Y2 side	SRCF output	SRCF side														
Output	SW8																				
General-purpose output	Y2 side																				
SRCF output	SRCF side																				

 Exercise caution as expected operation may not result if the setting above is not conducted accurately.

2.3 Attachment and Connection of Keypad

2.3.1 Parts required for connection

The following parts are necessary when attaching the keypad to locations other than the inverter main body.

Part name	Type	Remarks
Keypad extension cable (note 1)	CB-5S, CB-3S, CB-1S	Three lengths available (5 m, 3 m, 1 m) (3.3ft, 9.8ft, 16.4ft)
Keypad fixing screws	M3x□ (note 2)	2 screws required (prepared by user)

(Note 1) When using commercially available LAN cable, use 10BASE-T/100BASE-TX straight cables (below 20 meters) which meet the ANSI/TIA/EIA-568A category 5 standards of U.S.A.

Recommended LAN cable

Manufacturer: Sanwa Supply, Inc.

Type: KB-10T5-01K (for 1 meter)

KB-STP-01K (for 1 meter) (shielded cable when conforming to EMC directive)

(Note 2) When attaching to the cabinet, use a fixing screw of appropriate length to the cabinet thickness.

2.3.2 Attachment procedure

The keypad can be attached in the following forms.

- Attach to the inverter main body (refer to figure 2.3-1(a), (b), (c))
- Attach to the cabinet (refer to figure 2.3-2)
- Operate the panel remotely, on the hand (refer to Figure 2.3-3)

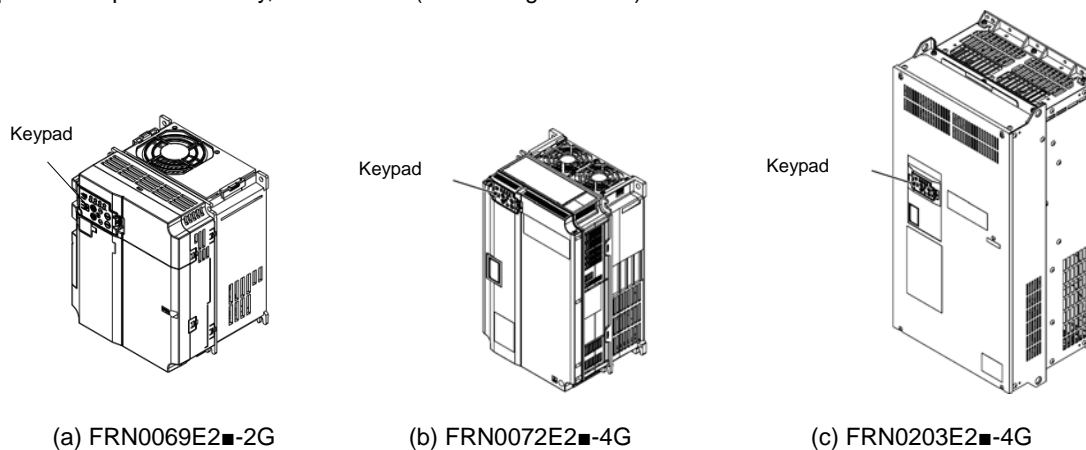

Figure 2.3-1 Attaching the Keypad to the Inverter Main Body

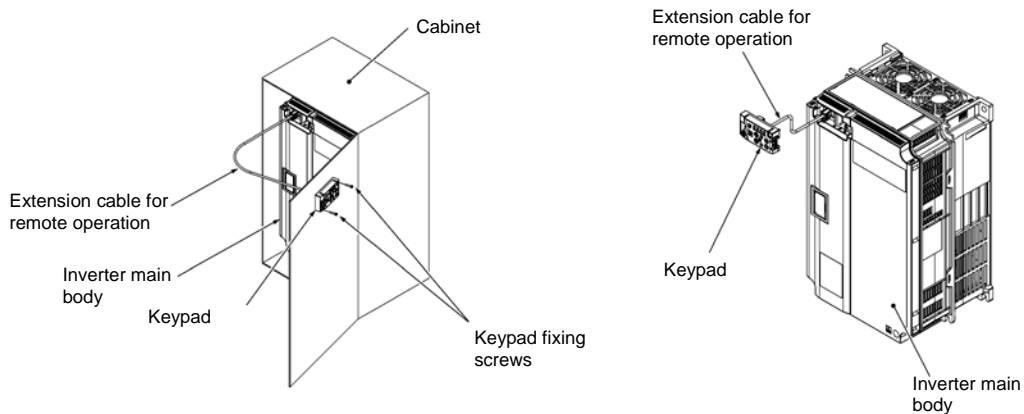

Figure 2.3-2 Attaching the Keypad on the Cabinet

Figure 2.3-3 Operating the Keypad Remotely, on the Hand

■ **Attachment to the cabinet**

- (1) Squeeze the hooks at the arrows and pull as shown in the figure below.

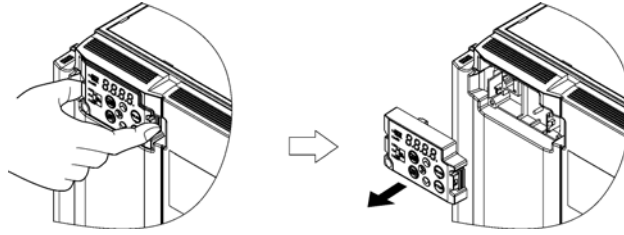

Figure 2.3-4 Removal of the Keypad

- (2) Attach the keypad rear cover to the keypad using the included keypad rear cover fixing screw.

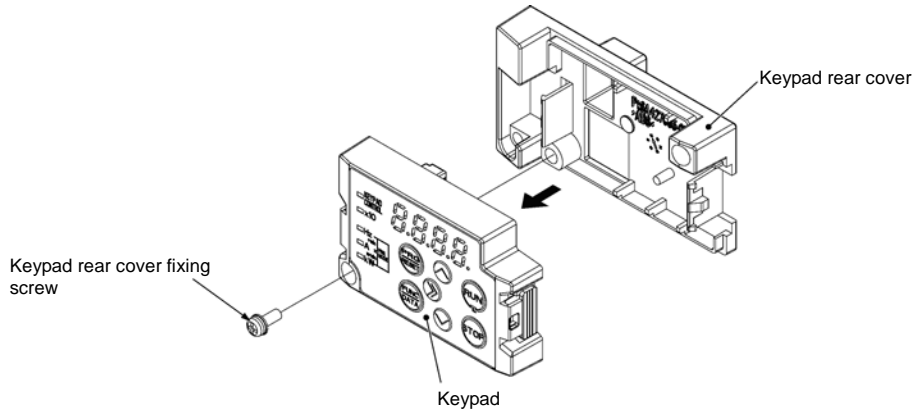

Figure 2.3-5 Attachment of the Keypad

(3) Cut the cabinet to attach the keypad, as shown in figure 2.3-6

(Units: mm [inch])

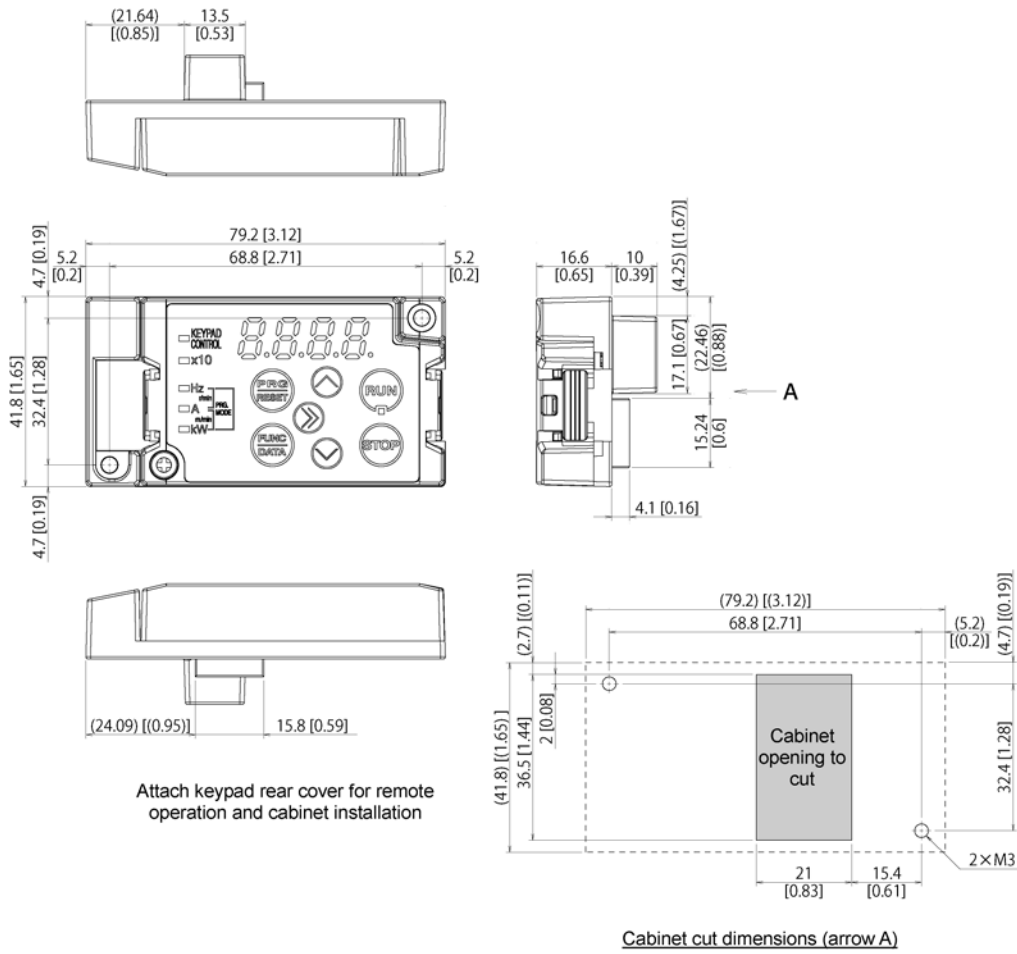

Figure 2.3-6 Fixing Screw Positions and the Dimensions of the Cabinet to Cut

- (4) Fix the keypad to the cabinet using 2 keypad rear cover fixing screws. Refer to figure 2.3-7 (tightening torque: 0.7 N•m(6.2lb-in)).

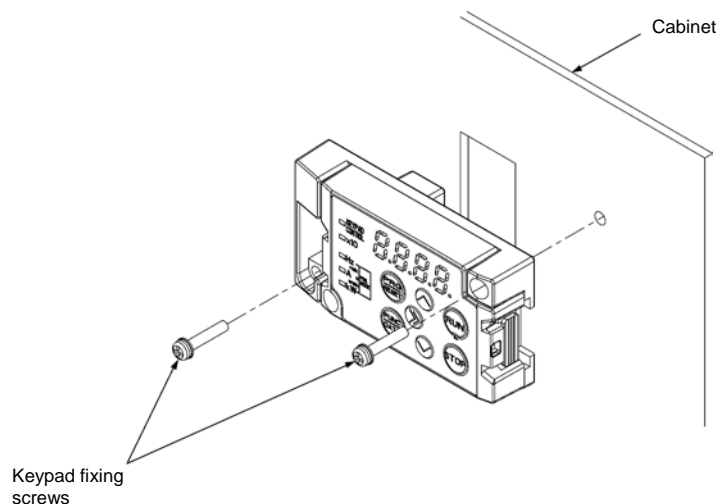

Figure 2.3-7 Attachment of the Keypad

- (5) Connect the extended cable for remote operation (CB-5S, CB-3S, CB-1S) or the commercially available LAN cable (straight) to the keypad RJ-45 connector and the inverter main body RJ-45 connector (modular jack). Refer to Figure 2.3-8.

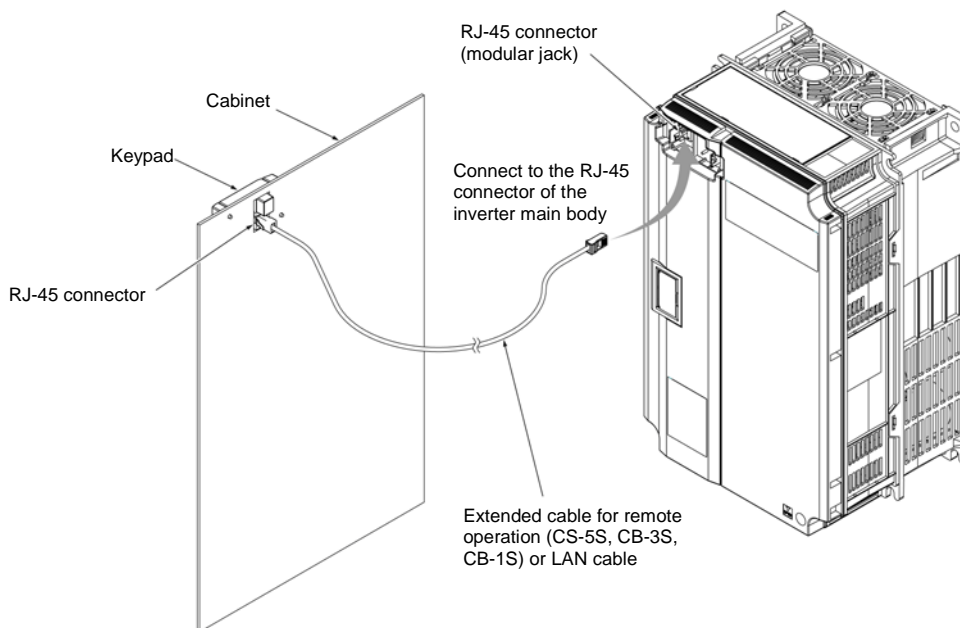

Figure 2.3-8 Connection of the Extension Cable or the Commercially Available LAN Cable between the Keypad and the Inverter Main Body

⚠ CAUTION

- The RJ-45 connector for keypad connection is specialized for keypad communication and does not support RS-485 communication. Connection with the PC loader is not possible.
- Do not connect the inverter to PC LAN ports, Ethernet hubs, or telephone lines. The inverter and the connected instrument may be damaged.

Risk of fire and risk of accidents exist.

■ Operating remotely, on the hand

Connect following the procedure (5) in "Attachment to the cabinet".

2.4 RJ-45 Cover

The opening for the RS-485 communication cable connection (RJ-45 connector) is located below the keypad, as shown in figure 2.4-1(a), (b).

■ Types-FRN0069E2-2G / FRN0044E2-4G-or below

To connect the RS-485 communication cable, open the RJ-45 cover as shown in the figure below.

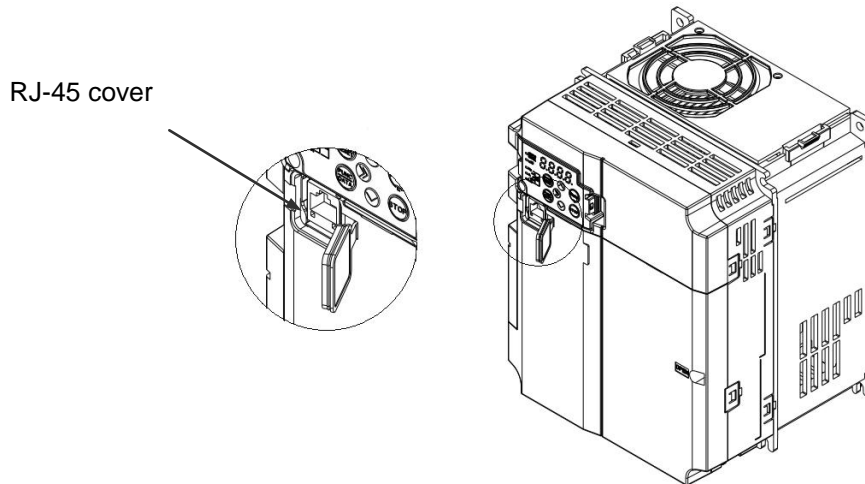

Figure 2.4-1 (a) Connection of the RS-485 Communication Cable

■ Types FRN0185E2-2G / FRN0059E2-4G or above

To connect the RS-485 communication cable, open the RJ-45 cover until the “click” can be heard and connect the cable as shown in the figure below.

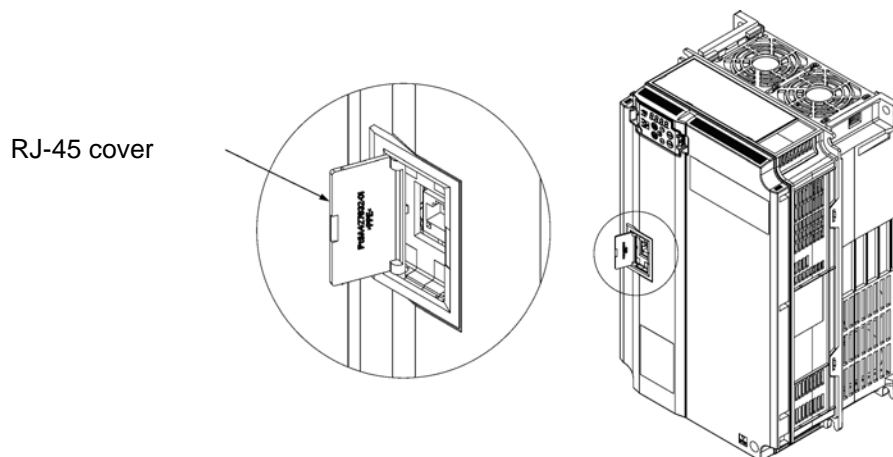

Figure 2.4-1 (b) Connection of the RS-485 Communication Cable

Connect with the PC via the RS-485 converter using the RS-485 communication cable. The PC loader allows editing, confirmation, and management of the inverter function codes, and monitoring of operation data remotely. The operating status and alarms can also be monitored.

Chapter 3 OPERATION USING THE KEYPAD

3.1 Names and Functions of Keypad Components

The keypad allows you to run and stop the motor, display various data, configure function code data, and monitor I/O signal states, maintenance information and alarm information.

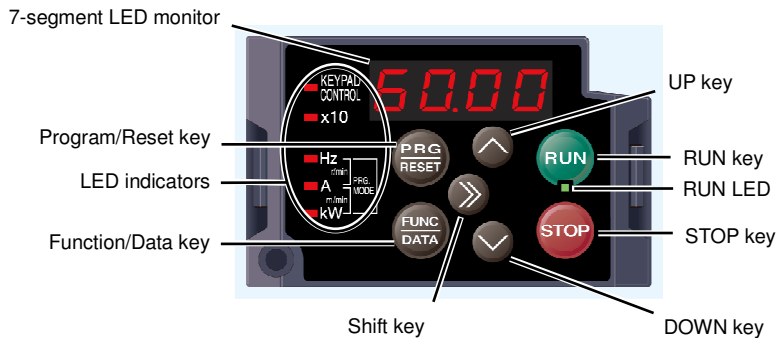





Table 3.1-1 Overview of Keypad Functions

Item	LED Monitor, Keys, and LED Indicators	Functions
LED Monitor		<p>Four-digit, 7-segment LED monitor which displays the followings according to the operation modes.</p> <ul style="list-style-type: none"> ■ In Running mode: Running status information (e.g., output frequency, current, and voltage) When a light alarm occurs, $L - FL$ is displayed. ■ In Programming mode: Menus, function codes and their data ■ In Alarm mode: Alarm code, which identifies the alarm factor that has activated the protective function.
Operation Keys		<p>Program/Reset key which switches the operation modes of the inverter.</p> <ul style="list-style-type: none"> ■ In Running mode: Pressing this key switches the inverter to Programming mode. ■ In Programming mode: Pressing this key switches the inverter to Running mode. ■ In Alarm mode: Pressing this key after removing the alarm factor resets the alarm and switches back to Running mode.
		<p>Function/Data key which switches the operations you want to do in each mode as follows:</p> <ul style="list-style-type: none"> ■ In Running mode: Pressing this key switches the information to be displayed concerning the status of the inverter (output frequency (Hz), output current (A), output voltage (V), etc.). When a light alarm is displayed, holding down this key resets the light alarm and switches back to Running mode. ■ In Programming mode: Pressing this key displays the function code or establishes the data entered with and keys. ■ In Alarm mode: Pressing this key displays the details of the problem indicated by the alarm code that has come up on the LED monitor.
		RUN key. Press this key to run the motor.
		STOP key. Press this key to stop the motor.
		UP and DOWN keys. Press these keys to select the setting items and change the function code data displayed on the LED monitor.
		Shift key. Press this key to shift the cursor to the right for entry of a numerical value.

Table 3.1-1 Overview of Keypad Functions (continued)

Item	LED Monitor, Keys, and LED Indicators	Functions
LED Indicators	RUN LED	Lights when running with a run command entered by the  key, by terminal command FWD or REV , or through the communications link.
	KEYPAD CONTROL LED	Lights when the inverter is ready to run with a run command entered by the  key (F02 = 0, 2, or 3). In Programming and Alarm modes, however, pressing the  key cannot run the inverter even if this indicator lights.
	Unit LEDs (3 LEDs)	<p>These three LED indicators identify the unit of numeral displayed on the LED monitor in Running mode by combination of lit and unlit states of them. Unit: Hz, A, kW, r/min and m/min</p> <p>Refer to Section ¡Error! No se encuentra el origen de la referencia. ¡Error! No se encuentra el origen de la referencia. for details.</p> <hr/> <p>While the inverter is in Programming mode, the LEDs of Hz and kW light.</p> <p style="text-align: right;"> <input checked="" type="checkbox"/> Hz <input type="checkbox"/> A <input checked="" type="checkbox"/> kW </p>
	x10 LED	<p>Lights when the data to display exceeds 9999. When this LED lights, the "displayed value x 10" is the actual value.</p> <p>Example: If data is "12,345," the LED monitor displays <i>1234</i> and the x10 LED lights, meaning that "1,234 × 10 = 12,340."</p>

■ LED monitor

In Running mode, the LED monitor displays running status information (output frequency, current or voltage); in Programming mode, it displays menus, function codes and their data; and in Alarm mode, it displays an alarm code which identifies the alarm factor that has activated the protective function.

If one of LED4 through LED1 is blinking, it means that the cursor is at this digit, allowing you to change it.

If the decimal point of LED1 is blinking, it means that the currently displayed data is a value of the PID command, not the frequency data usually displayed.

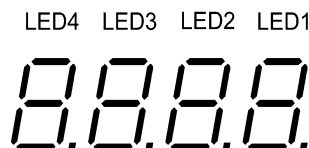

Figure 3.1-1 7-Segment LED Monitor

Table 3.1-2 Alphanumeric Characters on the LED Monitor

Character	7-segment	Character	7-segment	Character	7-segment	Character	7-segment
0	<i>0</i>	9	<i>9</i>	i	<i>,</i>	r	<i>r</i>
1	<i>1</i>	A	<i>A</i>	J		S	<i>S</i>
2	<i>2</i>	b	<i>b</i>	K		T	<i>T</i>
3	<i>3</i>	C	<i>C</i>	L	<i>L</i>	u	<i>u</i>
4	<i>4</i>	d	<i>d</i>	M	<i>M</i>	V	<i>V</i>
5	<i>5</i>	E	<i>E</i>	n	<i>n</i>	W	<i>W</i>
6	<i>6</i>	F	<i>F</i>	o	<i>o</i>	X	<i>X</i>
7	<i>7</i>	G	<i>G</i>	P	<i>P</i>	y	<i>y</i>
8	<i>8</i>	H	<i>H</i>	q	<i>q</i>	Z	<i>Z</i>
Special characters and symbols (numbers with decimal point, minus and underscore)							
0. - 9.	<i>0. - 9.</i>	-	<i>-</i>	_	<i>_</i>		

3.2 Overview of Operation Modes

The FRENIC-Ace features the following three operation modes.

Table 3.2-1 Operation Modes

Operation mode	Description
Running mode	When powered ON, the inverter automatically enters this mode. This mode allows you to specify the reference frequency, PID command value and etc., and run/stop the motor with the / keys. It is also possible to monitor the running status in real time. If a light alarm occurs, the $L - AL$ appears on the LED monitor.
Programming mode	This mode allows you to configure function code data and check a variety of information relating to the inverter status and maintenance.
Alarm mode	If an alarm condition arises, the inverter automatically enters Alarm mode in which you can view the corresponding alarm code* and its related information on the LED monitor. * Alarm code: Indicates the cause of the alarm condition. For details, first see Table 6.1 "Abnormal States Detectable ("Heavy Alarm" and "Light Alarm" Objects)" in Chapter 6, Section 6.1 "Protective Function," and then read the troubleshooting of each alarm.

Figure 3.2-1 shows the status transition of the inverter between these three operation modes.

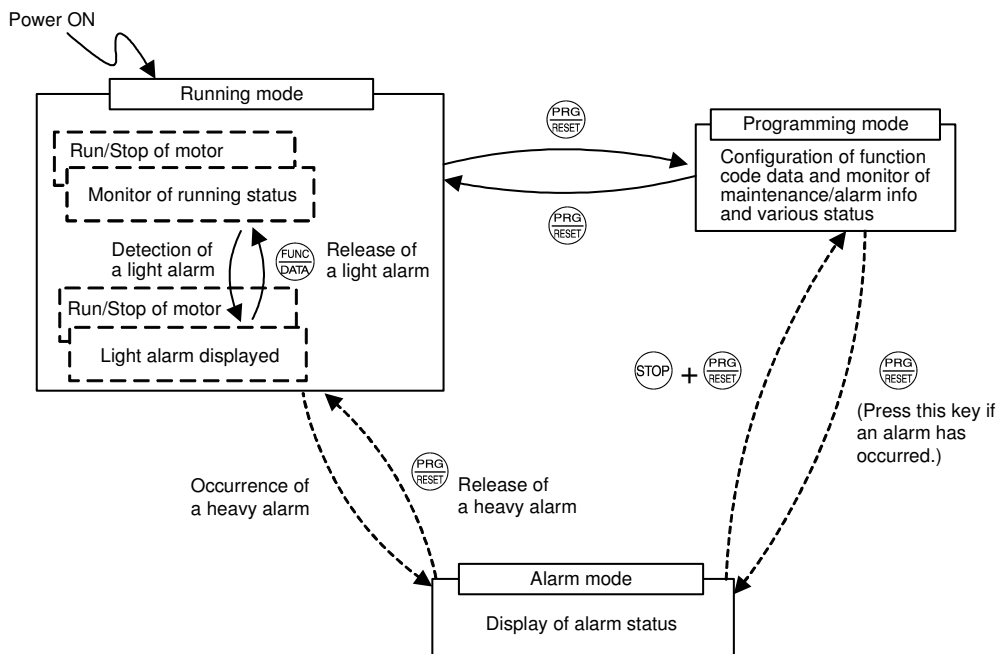

Figure 3.2-1 Status Transition between Operation Modes



Tip Simultaneous keying

Simultaneous keying means pressing two keys at the same time. The simultaneous keying operation is expressed by a "+" letter between the keys throughout this manual.

For example, the expression " + / keys" stands for pressing the / key with the key held down.

Figure 3.2-2 illustrates the transition of the LED monitor screen during Running mode, the transition between menu items in Programming mode, and the transition between alarm codes at different occurrences in Alarm mode.

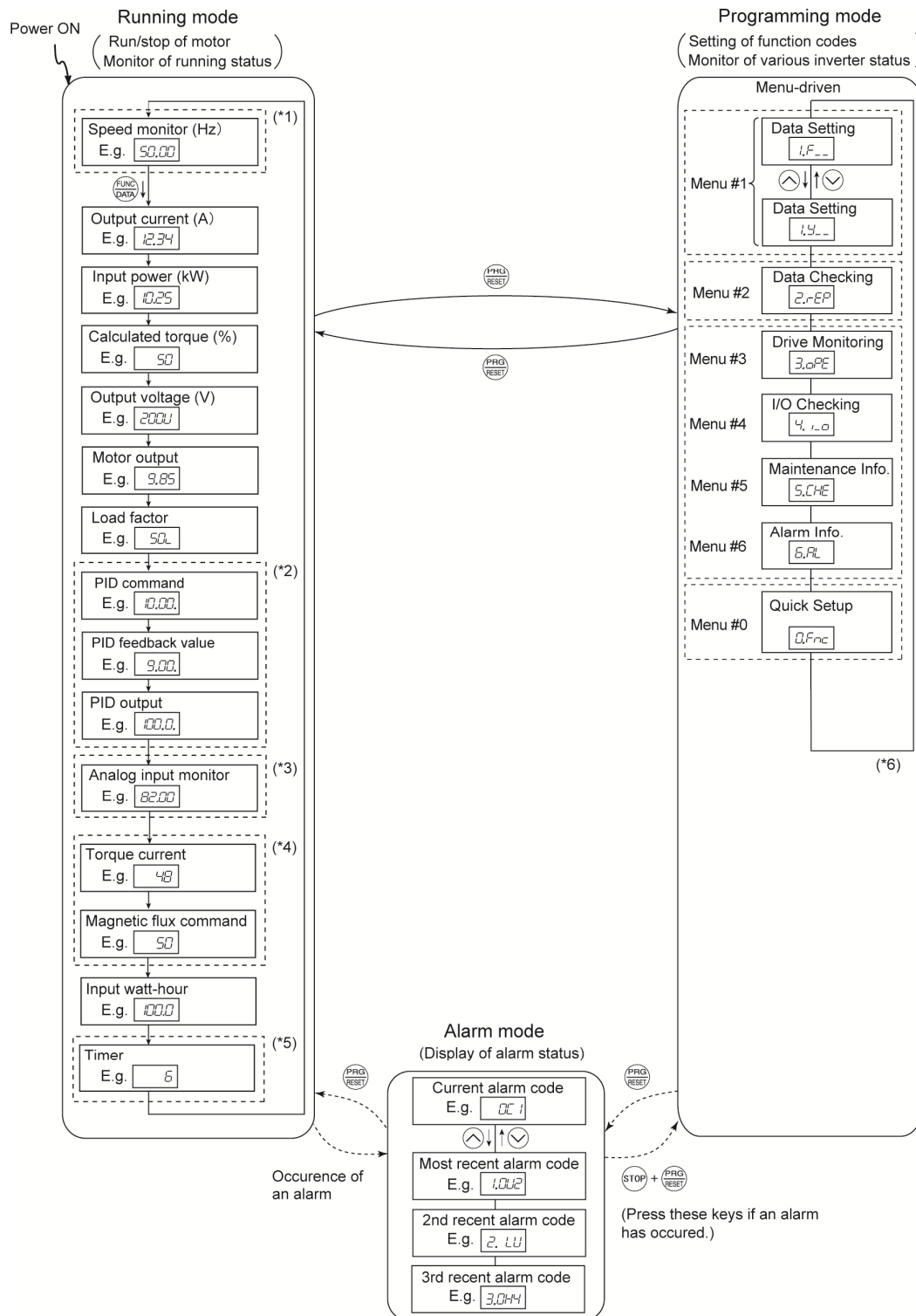

- (*1) The speed monitor allows you to select the desired one from the speed monitor items by using function code E48.
- (*2) Applicable only when PID control is active (J01 = 1, 2 or 3).
- (*3) The analog input monitor can appear only when the analog input monitor function is assigned to one of the analog input terminals by one of function codes E61 to E63 (= 20).
- (*4) \square appears under the V/f control.
- (*5) The Timer screen appears only when the timer operation is enabled with function code C21 (C21 = 1).
- (*6) Applicable only when the full-menu mode is selected (E52 = 2).

Figure 3.2-2 Transition between Basic Screens in Individual Operation Mode

Chapter 4 SET UP PROCEDURE

This chapter describes a simple step by step set up procedure of FRENIC-Ace for solar pumping application. Please refer to:

- chapter 2 for detailed information about installation and wiring
- chapter 3 for the information about the operation of the keypad
- chapter 5 for detailed description of the function codes.

In order to set up FRENIC-Ace for solar pumping application, please proceed with the following step by step procedure:

1. Install the inverter as described in chapter 2 of this manual.
2. Set up the motor parameters and, whenever possible, execute the auto tuning procedure. If the motor is already coupled with the load (pump) please execute static auto-tuning (P04=1). If the motor can be dismantled from the load please execute dynamic auto-tuning (P04=2), which measures more motor parameters than the static auto-tuning (for details, please refer to chapter 5). Some functions like the dry pump detection and low power detection will work with the best accuracy only if the motor parameters are correctly set.
3. Set up the parameter F02 (Operation method) to 1 (External signal).
4. Set up the parameter H11 (Deceleration mode) to 1 (Coast to a stop).
5. Set the PID control related parameters:
 - o J01 (Mode selection) to 2 (inverse operation)
 - o J02 (Remote command) to 1 (PID process command 1)
 - o J06 (Feedback filter) to 0.0s (No filter).
6. Set up the following parameters related to the PV panel specifications:
 - o Function code U126 (PV panel open circuit voltage) is used to set the PV panel open circuit voltage
 - o Function code U127 (PV panel MPP voltage) is used to set the PV panel MPP voltage
7. Set up the following parameters related to the MPP search (tracking) function:
 - o Function code U121 (Enable MPP search) must be set to "1.00" to enable the MPP search function
 - o Function code U135 (Voltage/PID set point increase/decrease step for MPP search) to set the set point increase/decrease at each step of the MPP search function.
8. Set up the parameters related to the sleep function:
 - o Function code J15 (Sleep frequency) to set the minimum frequency level to keep running, because the pump is not anymore effective when rotating at lower speeds than the value set in this function code. This setting depends mainly on the pump specifications.
 - o Function code U134 (Power level to keep running) to set the minimum power level to keep running. If the power level is very small, it means that the pump may not be effective anymore. This setting depends mainly on the pump specifications.

It is important to note that it is not compulsory to set both parameters. The inverter can use either the sleep frequency or the minimum power as the stop (sleep) criteria. In other words, it is not required to fulfill both conditions.

 **Note** Do not change the value of function code J17 from factory default value, otherwise it would interfere with the sleep and wake up functions.

9. Set up the following parameters related to the wake up function:
 - o Function code U131 (DC link voltage level to start) to set the minimum voltage level of the PV panel (DC link) to allow the operation of the inverter. This parameter is very important to avoid that the inverter (pump) starts operation when there is not enough available power from the PV panel. The value of this parameter can be set from PV panel specification or from tests at very low irradiance conditions (for example during sunset).

 **Note** Do not change the value of function code J17 from factory default value, otherwise it would interfere with the sleep and wake up functions.

10. Set up the initial parameters of the PID regulator:
 - PID controller gains J59 (P Gain 2) and J60 (I integral time 2), used when the PID feedback value is higher than the PID set point value. As initial values set the values recommended in chapter 5.
 - PID controller gains U132 (P Gain 1) and U133 (I integral time 1), used when the PID feedback value is lower than the PID set point value. As initial values set the values recommended in chapter 5.
11. Check that the function codes related to the digital inputs [FWD] and [REV] are set to “No function assigned”.
(📖 Function code E98, E99 data = 100)
12. If tank high level digital detection signal is used, check that the function code related to the digital input [X1] is set to “No function assigned”.
(📖 Function code E01 data = 100)
13. If tank level analog detection signal is used, set function code U128 (High level) to the desired maximum level of the tank. If this signal is not used, set function code U128 to 100%, to ensure that the pump starts (inverter operates) regardless of the value on the analog input of the inverter.
14. Ensure that function code U00 (Mode Selection) is set to 1, in order to enable the Solar Pumping application.

CAUTION

- When setting U00 to 1 the operation of the inverter may start (if all necessary conditions are fulfilled). Please ensure that it is safe to start operation.

An accident or physical injury may result.

Chapter 5 FUNCTION CODES

This chapter describes the function codes used to set FRENIC-Ace for Solar Pumping application.

5.1 Function Codes Table

The table below describes the function codes used to set up FRENIC Ace inverter for Solar Pumping application. For other function codes not described in this manual refer to FRENIC Ace User's Manual. In case of using PMS motor please refer to the FRENIC Ace User's Manual for the correct setting of motor parameters.

Code	Keypad code	Name	Data setting range	Factory default	Setting
F02	F02	Operation method	0: Keypad operation (rotation direction input: terminal block) 1: External signal (digital input) 2: Keypad operation (forward rotation) 3: Keypad operation (Reverse rotation)	2	1
F03	F03	Maximum output frequency 1	25.0 to 500.0 Hz	200V class AJKU:60.0 400V class ACE:50.0 JKU:60.0	App. (Note 1)
F04	F04	Base frequency 1	25.0 to 500.0Hz	200V class J:50.0 AUK:60.0 400V class ACEJ:50.0 UK:60.0	App. (Note 1)
F05	F05	Rated voltage at base frequency 1	0: AVR disable (output voltage proportional to power voltage) 80 to 240 V: AVR operation (200V class) 160 to 500V: AVR operation (400V class)	200V class J:200 AK:220 U:230 400V class	App. (Note 1)
F06	F06	Maximum output voltage 1	80 to 240V: AVR operation (200V class) 160 to 500V: AVR operation (400V class)	EJ:400 A:415 CK:380 U:460	App. (Note 1)
F07	F07	Acceleration time1	0.00 to 6000 s	6.00 or 20.0	6.00
F08	F08	Deceleration time1			0.50
F09	F09	Torque boost 1	0.0 to 20.0% (% value against base frequency voltage 1)	(Note 7)	App. (Note 1)
F10	F10	Electronic thermal overload protection for motor 1 (Select motor characteristics)	1: Enable (For a general-purpose motor with self-cooling fan) 2: Enable (For an inverter-driven motor (FV) with separately powered cooling fan)	1	App. (Note 1)
F11	F11	Electronic thermal overload protection for motor 1 (Overload detection level)	0.00 (disable), current value of 1 to 135% of inverter rated current (Inverter rated current dependent on F80)	(Note 3)	App. (Note 1)
F12	F12	Electronic thermal overload protection for motor 1 (Thermal time constant)	0.5 to 75.0 min	(Note 4)	App. (Note 1)
F37	F37	Load selection/ Auto torque boost/ Auto energy-saving operation 1	0: Variable torque load 1: Constant torque load 2: Auto torque boost 3: Auto energy-saving operation (variable torque load) 4: Auto energy-saving operation (constant torque load) 5: Auto energy-saving operation with auto torque boost	1	App. (Note 1)
F42	F42	Drive control selection 1	0: V/f control without slip compensation 1: Vector control without speed sensor (dynamic torque vector) 2: V/f control with slip compensation 3: V/f control with speed sensor 4: V/f control with speed sensor and auto torque boost 6: Vector control for induction motor with speed sensor 15: Vector control for synchronous motor without speed sensor nor pole position sensor	0	(Note 5)

Code	Keypad code	Name	Data setting range	Factory default	Setting
F80	F80	Switching between ND,HD,HND and HHD drive modes	0: HHD mode 1: HND mode 3: HD mode 4: ND mode ND/HD mode is not supported for 200V class series.	4	(Note 6)
E01	E01	Terminal [X1] function	Refer to User Manual	0	100
E98	E98	Terminal [FWD] function		98	100
E99	E99	Terminal [FWD] function		99	100
E20	E20	Terminal [Y1] function		0	111
E21	E21	Terminal [Y2] function	7	112	
E27	E27	Terminal [30A/B/C] function	99	99	
P01	P01	Motor 1 (No. of poles)	2 to 22 poles	4	App. (Note 1)
P02	P02	Motor 1 (Rated capacity)	0.01 to 1000 kW (At P99 = 0 or 4, 15) 0.01 to 1000 HP (At P99 = 1)	(Note 7)	App. (Note 1)
P03	P03	Motor 1 (Rated current)	0.00 to 2000A	(Note 7)	App. (Note 1)
P04	P04	Motor 1 (Auto tuning)	0: Disable 1: Stop tuning 2: Rotation tuning 5: Stop tuning (%R1, %X)	0	-
P06	P06	Motor 1 (No-load current)	0.00 to 2000A	(Note 7)	App. (Note 1)
P07	P07	Motor 1 (%R1)	0.00 to 50.00%	(Note 7)	App. (Note 1)
P08	P08	Motor 1 (%X)	0.00 to 50.00%	(Note 7)	App. (Note 1)
P12	P12	Motor 1 (Rated slip frequency)	0.00 to 15.00 Hz	(Note 7)	App. (Note 1)
H03	H03	Data initialization	0: Manual setting value 1: Initial value (factory default value) 2: Initialize motor 1 parameters 3: Initialize motor 2 parameters 11: Initialize the parameters(excluding parameters related to communication) 12: Initialize the parameters related to customizable logic	0	-
H06	H06	Cooling fan ON/OFF control	0: Disable (Always Fan ON) 1: Enable (ON/OFF control effective)	0	0
H11	H11	Deceleration mode	0: Normal deceleration 1: Coast to a stop	0	1
H50	H50	Non-linear V/f 1 (Frequency)	0.0 (Cancel), 0.1 to 500.0 Hz	0.0	App. (Note 1)
H51	H51	Non-linear V/f 1 (Voltage)	0 to 240 V: AVR operation (200 V class) 0 to 500V: AVR operation (400V class)	0	App. (Note 1)
H52	H52	Non-linear V/f 2 (Frequency)	0.0 (Cancel), 0.1 to 500.0 Hz	0.0	App. (Note 1)
H53	H53	Non-linear V/f 2 (Voltage)	0 to 240 V: AVR operation (200 V class) 0 to 500V: AVR operation (400V class)	0	App. (Note 1)
H72	H72	Main power shutdown detection (Mode selection)	0: Disables main circuit power cutoff detection 1: Enables main circuit power cutoff detection (Only for)	1	0
H111	H111	UPS operation level	150 to 220 VDC: (200 V class) 240 to 440 VDC: (400 V class)	220 440	150 240
J01	J01	PID control (Mode selection)	0: Disable 1: Process (normal operation) 2: Process (inverse operation) 3: Speed control (Dancer)	0	2
J02	J02	PID control (Remote command)	0: Keypad key operation (/ key) 1: PID process command 1 (Analog input: Terminals 12, C1 and V2) 3: UP/DOWN 4: Communication	0	1
J06	J06	PID control (Feedback filter)	0.0 to 900.0 s	0.5	0.0
J59	J59	PID control P (Gain) 2	0.000 to 30.000 times	0.100	1.2 (Note 1)
J60	J60	PID control I (Integral time) 2	0.0 to 3600.0 s	0.0	1.0 (Note 1)

Code	Keypad code	Name	Data setting range	Factory default	Setting
U132	U132	PID gains switching (P gain 1 for fast reaction, Feedback < Set point)	0.00 to 30.00 times	0.00	1.4 (Note 1)
U133	U133	PID gains switching (I Integral time 1 for fast reaction, Feedback < Set point)	0.0 to 3600.0 s	0.00	0.3 (Note 1)
y20	y20	RS-485 Communication 2 (Protocol selection)	0: Modbus RTU protocol 1: FRENIC Loader protocol (SX protocol) 2: Fuji general-purpose inverter protocol	0	App. (Note 1)
U128	U128	Tank level detection function (High level)	0.00 to 100.0% 100%: Maximum detection level	0.00	100.0
UA14	U15	Tank level detection function (High level hysteresis width)	0.00 to 100.0% 100%: Maximum detection level	5	5
UA18	U19	Tank level detection function (Signal ON Delay Time)	0.00 to 60 s	15	15
UA23	U24	Tank level detection function (Signal OFF Delay Time)	0.00 to 60 s	15	15
U130	U130	Low power detection function (Low Power level)	0.00 to 100.0% 100%: Motor rated power (P02)	0.00	App. (Note 1)
UA48	U49	Low power detection function (Signal ON Delay Time)	0.00 to 60 s	15	15
UA53	U54	Dry pump detection function (Output frequency level)	0.00 to 100.0% 100%: Maximum frequency (F03)	80	80
UA54	U55	Dry pump detection function (Output frequency hysteresis width)	0.00 to 100.0% 100%: Maximum frequency (F03)	5	5
UA68	U69	Dry pump detection function (Motor power level)	0.00 to 100.0% 100%: Motor rated power (P02)	30	30
UA69	U70	Dry pump detection function (Motor power hysteresis width)	0.00 to 100.0% 100%: Motor rated power (P02)	5	5
UA73	U194 (U190=15)	Dry pump detection function (Signal ON Delay Time)	0.00 to 60 s	15	15
U124	U124	Dry pump detection function (Enable Dry Pump Alarm)	0.00: Disable dry pump alarm (OH2) 1.00: Enable dry pump alarm (OH2)	0.00	0.00
U126	U126	PV panel specifications (PV panel open circuit voltage)	0.00 to 1000 V	0.00	App. (Note 1)
U127	U127	PV panel specifications (PV panel MPP voltage)	0.00 to 1000 V	0.00	App. (Note 1)
U172	U172	Measurement at open circuit voltage condition (affected by multiplication factor U127/U126)	0.00 to 100.0% 100%=500V (-2/-7), 1000V (-4)	-	-
U121	U121	MPP search (Enable MPP search)	0.00: Disable MPP search 1.00: Enable MPP search	0.00	1.00
U123	U123	MPP search (Enable manual setting of PV panel voltage set point)	0.00: Disable manual setting of U171 1.00: Enable manual setting of U171	0.00	0.00
U171	U171	MPP search (Actual PV panel voltage set point)	0.00 to 100.0% 100%=500V (-2/-7), 1000V (-4)	0.00	App. (Note 1)
U135	U135	MPP search (Voltage/PID set point increase/decrease step for MPP search)	0.00 to 100.0% 100%=500V (-2/-7), 1000V (-4)	0.00	0.20
UB88	U194 (U190=38)	MPP search (Time interval)	0.01 to 1.00	0.02	0.02
J15	J15	Sleep function (Sleep frequency)	0.0 (Disable): 1.0 to 500.0 Hz	0.0	App. (Note 1)
U134	U134	Sleep function (Power level to keep Running)	0.00 to 100.0% 100%: Motor rated power (P02)	0.00	25.0
UD88	U194 (U190=78)	Sleep function (Sleep time)	0.00 to 60 s (recommended range)	40	40
U131	U131	Wake up function (DC link voltage level to start)	0.00 to 500 V: (200V class) 0.00 to 1000 V: (400V class)	0.00	250 500
UD98	U194 (U190=80)	Wake up function (time)	0.00 to 180 s (recommended range)	60	60
U125	U125	Big step detection (Disable)	0.00: Enable big step 1.00: Disable big step	0.00	0.00
UI08	U194 (U190=162)	Big step detection (Dead time for next action)	0.00 to 20.0 s (recommended range)	6.00	6.00
UH18	U194 (U190=144)	Big step UP detection (Level to detect big step UP)	0.00 to 100.0% 100%=500V (-2/-7), 1000V (-4)	3	3
UH48	U194 (U190=150)	Big step UP detection (Time to follow the step UP change)	0.00 to 4.0 s (recommended range)	1.0	1.0

Code	Keypad code	Name	Data setting range	Factory default	Setting
UH53	U194 (U190=151)	Big step DOWN detection (Level to detect big step DOWN)	0.00 to 100.0% 100%=500V (-2/-7), 1000V (-4)	3	3
UH83	U194 (U190=157)	Big step DOWN detection (Time delay to follow the step DOWN)	0.00 to 10.0 s (recommended range)	4.0	4.0
UH88	U194 (U190=158)	Big step DOWN detection (Time to follow the step DOWN change)	0.00 to 4.0 s (recommended range)	1.0	1.0
U00	U00	Customizable logic (Mode selection)	0: Disable 1: Enable (Customizable logic operation) ECL alarm occurs when the value is changed from 1 to 0 during operation.	0	1

(Note 1): Depends on the application

(Note 2): Please set U190 to the number inside the brackets prior to changing this function

(Note 3): The motor rated current is automatically set. Refer to Table B (function code P03)

(Note 4): 5.0min for inverters of nominal applied motor 22kW or below; 10.0min for those of 30kW or above

(Note 5): For solar pumping application recommended setting is 0 or 1

(Note 6): For solar pumping application recommended modes are HND or HHD

(Note 7): Depends on motor capacity

5.2 Description of Function Codes

This section describes details of function codes relevant for Solar Pumping application.

F02	Operation method	Related function codes:	Terminal E98 [FWD] function Terminal E99 [REV] function
------------	-------------------------	--------------------------------	--

F02 is used to select the method how run command is provided to the inverter. In case of Solar pumping application please set F02 to 1, so that the operation command can be given from Customized Logic program.

Digital input signal, "FWD", "REV" should not be assigned to terminals [FWD], [REV], therefore please assign the function of these terminals to "No function".

(📖 Function code E98, E99 data = 100)

 • F02 cannot be changed when "FWD" or "REV" is ON.

F03	Maximum frequency 1
------------	----------------------------

F03 specifies the maximum frequency that the inverter outputs. When the device to be driven is set to rated or higher, the device may be damaged. Make sure to make an adjustment according to the design of the machinery.

- Data setting range: 25.0 to 500.0 (Hz)

Modes	Control mode	Data setting range	Remarks
HD/HND/HHD mode	V/f control	500 Hz	
ND mode	V/f control	120 Hz	Restricted internally.*

* When setting is performed by exceeding the maximum setting range (for example, 500 Hz), speed setting and analog output (FMA) become input/output mode of full scale/setting value (10V/ 500Hz). However, it is internally restricted (for example, 120Hz), therefore, even if 10V is input for setting value, the value is restricted internally by 2.4 V (equivalent to 120 Hz), not by 500Hz.

Use function code F80 to switch between ND, HD, HND and HHD drive modes.

 WARNING
Inverter can perform setting of high speed operation easily. When changing the setting, make sure to check the motor and machine mode before use.
Injuries could occur. Failure may occur.

 When changing maximum output frequency (F03), in order to make the operation frequency a larger value, change the frequency limiter (upper limit) (F15) as well.

F04, F05 F06	Base frequency 1, Rated voltage at base frequency 1
	Maximum output voltage 1
	Related function codes
	H50, H51 Non-linear V/f 1 (Frequency, voltage)
	H52, H53 Non-linear V/f 2 (Frequency, voltage)
	H65, H66 Non-linear V/f 3 (Frequency, voltage)

Set the base frequency and base frequency voltage that are essential to operation of the motor. By combining related function codes H50 to H53, H65, and H66, it is possible to set non-linear V/f pattern (weak or strong voltage by arbitrary point) and perform setting of V/f characteristics that is suitable for the load.

Impedance of the motor becomes larger with high frequency, and when output voltage becomes less, output torque may be reduced. In order to prevent this, increase the voltage at high frequency by setting function code F06 (maximum output voltage 1). However, it is not possible to output voltage at or higher than the input power voltage of the inverter.

Point of V/f	Function code		Remarks
	Frequency	Voltage	
Maximum output frequency	F03	F06	During auto torque boost, vector control without speed sensor, the maximum output voltage setting is disabled.
Base frequency	F04	F05	
Non-linear V/f 3	H65	H66	This code is disabled during auto torque boost, vector control without speed sensor.
Non-linear V/f 2	H52	H53	
Non-linear V/f 1	H50	H51	

<Setting example>

■ **Normal V/f pattern setting**

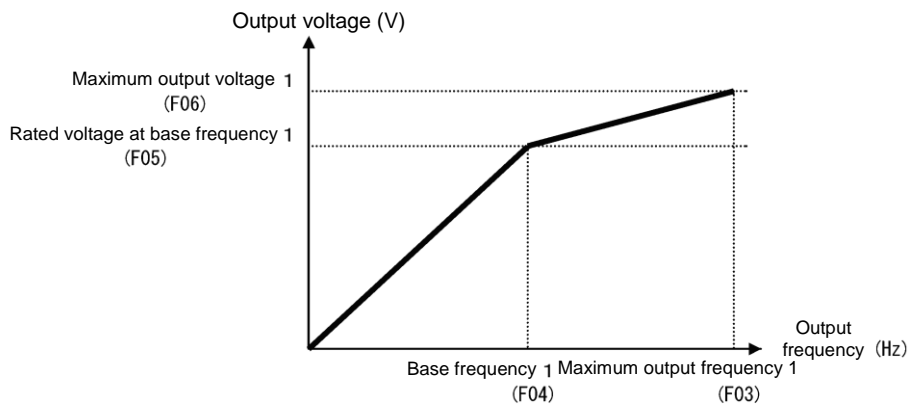

■ **Non-linear V/f pattern setting (3 points)**

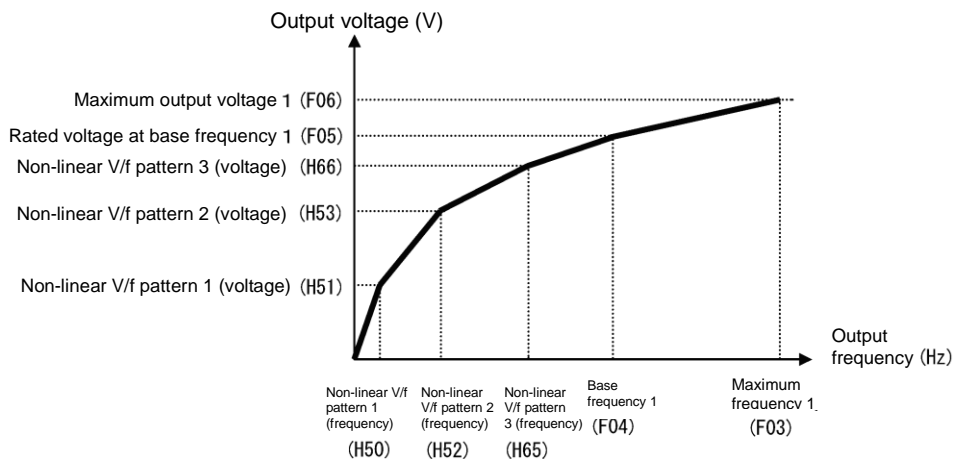

■ Base frequency (F04)

Set the data in accordance with rated frequency of the motor (given on the nameplate of the motor).

- Data setting range: 25.0 to 500.0 (Hz) (limited to 120 Hz (max.) in ND mode)

■ Rated voltage at base frequency (F05)

Set the data to "0" or in accordance with rated voltage of the motor (given on the nameplate of the motor).

- Data setting range: 0 : AVR disable
80 to 240 (V) : AVR operation (at 200 V class)
160 to 500 (V) : AVR operation (at 400 V class)
- When data is set to "0", the base frequency voltage becomes equivalent to inverter input voltage. When input voltage fluctuates, output voltage fluctuates as well.
- When data is set to arbitrary voltage other than "0", automatically keeps the output voltage constant. When control function such as auto torque boost, auto energy-saving operation, and skip compensation is used, it is necessary to adjust to the rated voltage (given on the nameplate of the motor) of the motor.

 **Note** The voltage that the inverter can output is lower than the input voltage of the inverter. Appropriately set the voltage in accordance with the motor.

■ Non-linear V/f 1, 2, 3 (Frequency) (H50, H52, H65)

Set frequency at the arbitrary point of non-linear V/f pattern.

- Data setting range: 0.0 (Cancel), 0.1 to 500.00 (Hz)

 **Note** When 0.0 is set, the setting becomes the pattern without using non-linear V/f pattern. (limited to 120 Hz (max.) in ND mode)

■ Non-linear V/f 1, 2, 3 (Voltage) (H51, H53, H66)

Set voltage at the arbitrary point of non-linear V/f pattern.

- Data setting range: 0 to 240 (V) : AVR operation (at 200 V class)
0 to 500 (V) : AVR operation (at 400 V class)

■ Maximum output voltage 1 (F06)

Set the voltage at maximum output frequency 1 (F03).

- Data setting range: 80 to 240 (V) : AVR operation (at 200 V class)
160 to 500 (V) : AVR operation (at 400V class)

 **Note** When rated voltage at base frequency (F05) is "0", the data of non-linear V/f (H50 to H53, H65, and H66) and F06 becomes invalid (linear V/f for at or below base frequency, and constant voltage for at or higher than base frequency).

F07, F08**Acceleration time1, Deceleration time1****(Refer to F37)**

Acceleration time sets the time taken by the output frequency to reach the maximum output frequency from 0Hz, and deceleration time sets the time taken by the output frequency to reach 0Hz from the maximum frequency.

- Data setting range: 0.00 to 6000 (s)

For V/f control

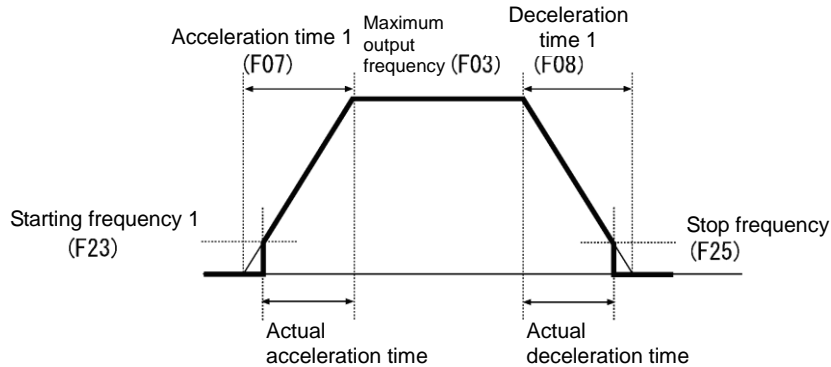
**F09****Torque boost 1****(Refer to F37)**

For details of torque boost 1 setting, refer to the section of function code F37.

F10 to F12**Electronic thermal overload Protection for motor 1 (Select motor characteristics, Thermal time constant)**

In order to detect overload of motor (electronic thermal function by inverter output current), set temperature characteristics of motor: Select motor characteristics (F10), thermal time constant (F12), and overload detection level (F11).

When overload of motor is detected, inverter is turned off, protecting the motor with motor overload alarm *0/1*.

- Note** Improper setting of the electronic thermal function may result in a failure to protect the motor from burning.
- Note** Temperature characteristics of motor is used for motor overload early warning "OL" as well. Even if only overload early warning is used, it is necessary to set temperature characteristics of the motor (F10, F12). (📖 Function code E34)
- Note** For disabling motor overload alarm, set F11 = 0.00 (Disable).
- Note** For PTC thermistor built-in motor, by connecting PTC thermistor to terminal [C1], it is possible to protect the motor. Refer to H26 to find the details.

■ **Select motor characteristics (F10)**

F10 selects characteristics of cooling system of the motor.

F10 data	Function
1	Self-cooling fan of general-purpose motor (Self-cooling) (When operating with low frequency, cooling performance decreases.)
2	Inverter-driven motor, High-speed motor with separately powered cooling fan (Keep constant cooling capability irrespective to output frequency)

The following diagram shows electronic thermal operation characteristics diagram when F10=1 is set. The characteristics coefficient $\alpha 1$ and $\alpha 3$ and the switch coefficient $f 2$, $f 3$ differ depending on the characteristics of the motor.

Each coefficient that is set by motor characteristics that is selected by motor capacitance and motor selection (P99) is shown in the table below.

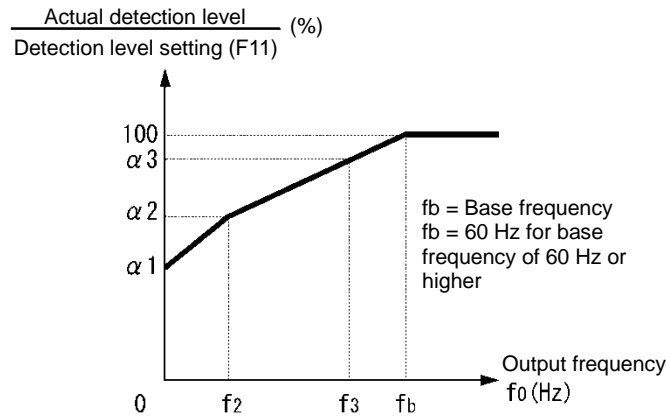

Characteristics diagram of motor cooling system

When P99 = 0, 4 (Motor characteristics 0, other)

Motor capacity	Thermal time constant τ (Factory default)	Thermal time constant setting Standard current value I_{max}	Characteristics coefficient switch frequency		Characteristics coefficient		
			$f 2$	$f 3$	$\alpha 1$	$\alpha 2$	$\alpha 3$
0.4, 0.75 kW	5 min	Continuous allowance current value x 150%	5 Hz	7Hz	75%	85%	100%
1.5 to 3.7 kW					85%	85%	100%
5.5 to 11 kW				6Hz	90%	95%	100%
15 kW				7Hz	85%	85%	100%
18.5, 22 kW				5Hz	92%	100%	100%
30 to 45 kW	10 min		Base frequency x 33%	Base frequency x 83%	54%	85%	95%
55 to 90 kW					51%	95%	95%
110 kW or above					53%	85%	90%

When P99 = 1 (Motor characteristics 1)

Motor capacity	Thermal time constant τ (Factory default)	Thermal time constant setting Standard current value I_{max}	Characteristics coefficient switch frequency		Characteristics coefficient		
			$f 2$	$f 3$	$\alpha 1$	$\alpha 2$	$\alpha 3$
0.2 to 22 kW	5 min	Continuous allowance current value x 150%	Base frequency x 33%	Base frequency x 33%	69%	90%	90%
30 to 45 kW	10 min			Base frequency x 83%	54%	85%	95%
55 to 90 kW					51%	95%	95%
110 kW or above					53%	85%	90%

When P99 = 20, 21 (Motor characteristics)

Motor capacity	Thermal time constant τ (Factory default)	Thermal time constant setting Standard current value I_{max}	Characteristics coefficient switch frequency		Characteristics coefficient		
			f_2	f_3	α_1	α_2	α_3
18.5 kW to less than 110 kW	5 min	Continuous allowance current value x 150%	Base frequency x 33%	Base frequency x 83%	53%	85%	95%
110 kW or above	10 min				53%	85%	90%

When F10=2 is set, cooling effect by output frequency will not decrease, therefore, overload detection level becomes constant value (F11) without decrease.

■ Overload detection level (F11)

F11 sets operation level of electronic thermal.

- Data setting range: 1 to 135% of the rated current value of inverter (continuous allowance current value)

Normally, set to the motor continuous allowance current (in general, about 1.0 to 1.1 times of motor rated current) when operating at base frequency.

For disabling electronic thermal, set F11 = 0.00: Disable.

■ Thermal time constant (F12)

F12 sets thermal time constant of the motor. For overload detection level that is set by F11, set the electronic thermal operation time when 150% of current is flowing continuously. Thermal time constant of general-purpose motor of Fuji Electric and general motors is 5 minutes for 22 kW or lower, and 10 minutes (factory default state) for 30kW or higher.

- Data setting range: 0.5 to 75.0 (min)

(Example) When the data of function code F12 is set to "5" (5 minutes).

As shown in the diagram below, when 150% of current of operation level that was set flows for 5 minutes, motor overload (alarm O1) protection function will operate. In addition, with 120%, it operates after 12.5 minutes.

The time when alarm actually occurs is shorter than the set data because the time until the current reaches 150% level after exceeding the continuous allowance current (100%) is considered.

<Example of current-operation time characteristics>

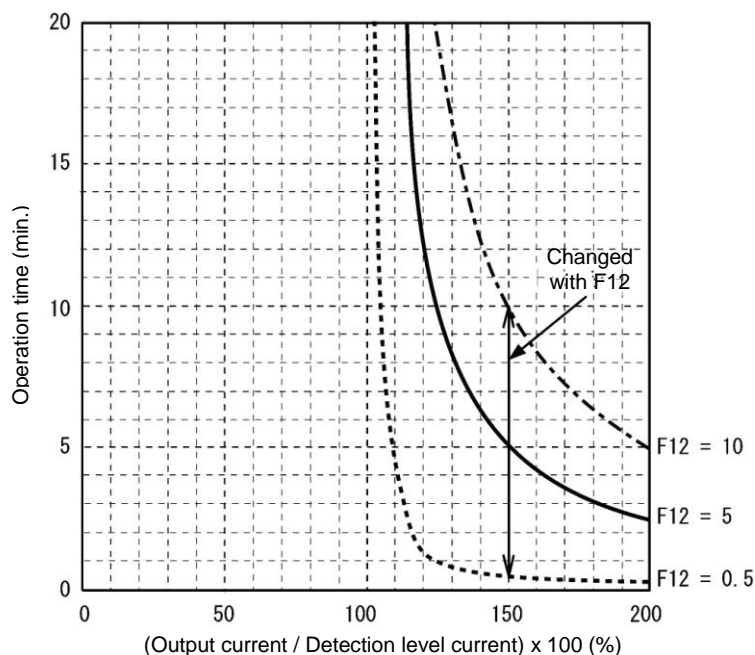

F14**Restart mode after momentary power failure (Mode selection)**

This parameter is used to set the operation for when momentary power failure occurs (trip operation, restart operation method at auto-restarting). For solar pumping application please set this parameter to 5.

■ **Restart mode after momentary power failure (Mode selection) (F14)**

V/f control (F42=0, 2, 3), dynamic torque vector control (F42=1, 4), PM motor control (F42=15)

F14 data	Operation contents	
	Without auto search	With auto search
5: Restart from starting frequency	When momentary power failure occurs while operating the inverter, and at the time when undervoltage is detected by the DC link bus voltage of the inverter, the inverter output shuts down, and the motor coasts to a stop.	
	If run command is entered at auto-restarting, restart from the starting frequency that was set by function code F23.	If run command is entered at auto-restarting, auto-searching is performed, motor speed is estimated, and restart from the frequency.
	This setting is most suitable for the case (pump etc.) when load inertia moment is small, when the load is heavy, and motor speed decreases up to 0 in a short time after the motor coasts to a stop due to momentary power failure.	

⚠ WARNING

When momentary power failure restart operation (F14 = 3 to 5) is selected, operation will resume automatically at auto-restarting. Design your machinery so that safety is ensured even at restarting.

Otherwise an accident could occur.

F37

Load Selection/Auto Torque Boost/Auto Energy Saving Operation 1
Related function codes F09 Torque boost 1

F37 specifies V/f pattern, torque boost type, and auto energy saving operation in accordance with the characteristics of the load.

F37 data	V/f characteristics	Torque boost	Auto Energy-saving Operation	Applicable load
0	Variable torque V/f pattern	By F09 torque boost	Disabled	Variable torque load (General-purpose fan and pumps)
1	Linear V/f pattern	Auto torque Boost		Constant torque load
2				Constant torque load (To be selected if a motor may be over-excited at no load)
3	Variable torque V/f pattern	By F09 torque boost	Enabled	Variable torque load (General-purpose fan and pumps)
4	Linear V/f pattern	Auto torque Boost		Constant torque load
5				Constant torque load (To be selected if a motor may be over-excited at no load)

Note If a required "load torque + acceleration torque" is 50% or more of the rated torque, it is recommended to select the linear V/f pattern. Factory defaults are set to linear V/f pattern.

■ **V/f characteristics**

The FRENIC-Ace series of inverters offer a variety of V/f patterns and torque boosts, which include V/f patterns suitable for variable torque load such as general fans and pumps and for constant torque load (including special pumps requiring high starting torque). Two types of torque boosts are available: manual and automatic.

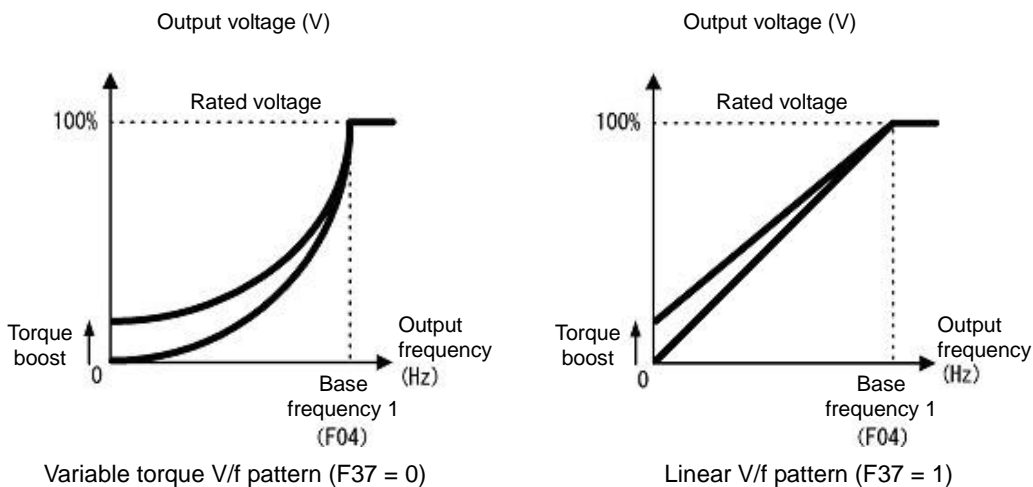

Tip When the variable torque V/f pattern is selected (F37 = 0 or 3), the output voltage may be low at a low frequency zone, resulting in insufficient output torque, depending on the characteristics of the motor and load. In such a case, it is recommended to increase the output voltage at the low frequency zone using the non-linear V/f pattern.

Recommended value: H50 = 1/10 of the base frequency
H51 = 1/10 of the voltage at base frequency

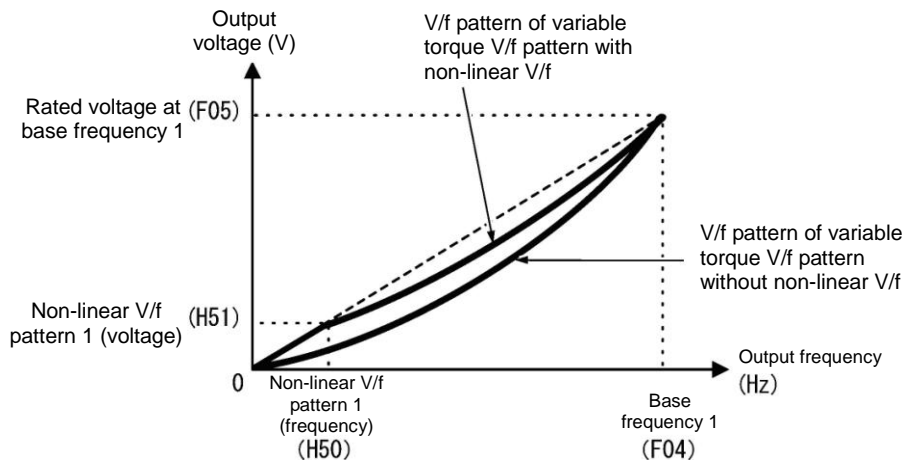

■ Torque boost

- **Manual torque boost by F09 (Manual adjustment)**

- Data setting range: 0.0 to 20.0 (%), (100%/base frequency voltage)

In torque boost using F09, constant voltage is added to the basic V/f pattern, regardless of the load. To secure a sufficient starting torque, manually adjust the output voltage to optimally match the motor and its load by using F09. Specify an appropriate level that guarantees smooth startup and yet does not cause over-excitation at no or light load. Torque boost using F09 ensures high driving stability since the output voltage remains constant regardless of the load fluctuation. Specify the function code F09 data in percentage to the base frequency voltage. At factory shipment, boost amount with which approx. 100% of starting torque can be assured, is specified.



- Specifying a high torque boost level will generate a high torque, but may cause overcurrent due to over-excitation at no load. If you continue to drive the motor, it may overheat. To avoid such a situation, adjust torque boost to an appropriate level.
- When the non-linear V/f pattern and the torque boost are used together, the torque boost takes effect below the frequency on the non-linear V/f pattern's point.

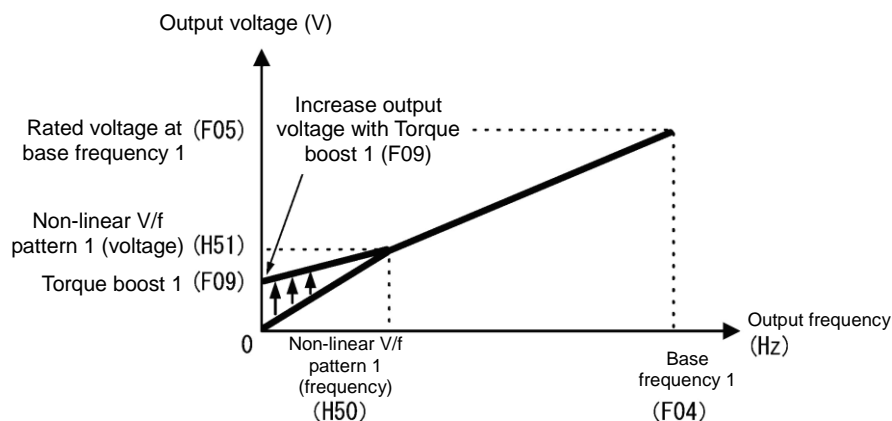

- **Auto torque boost**

This function automatically optimizes the output voltage to fit the motor with its load. Under light load, auto torque boost decreases the output voltage to prevent the motor from over-excitation. Under heavy load, it increases the output voltage to increase the output torque of the motor.



- This function controls in accordance with motor characteristics. Therefore, set the base frequency 1 (F04), rated voltage at base frequency 1 (F05), and other pertinent motor parameters (P01 through P03 and P06 through P99) in line with the motor capacity and characteristics, or else perform auto-tuning (P04).
- When a special motor is driven or the load does not have sufficient rigidity, the maximum torque might decrease or the motor operation might become unstable. In such cases, do not use auto torque boost but choose manual torque boost using F09 (F37 = 0 or 1).

F42	Drive control selection 1 Related function codes: H68 Slip Compensation 1 (Operating conditions)
------------	---

F42 specifies the motor drive control.

F42 data	Control mode	Basic control	Speed feedback	Speed control
0	V/f control without slip compensation	V/f control	Disable	Frequency control
1	Vector control without speed sensor (dynamic torque vector)			With slip compensation Frequency control
2	V/f control with slip compensation		Enable	Frequency control with automatic speed regulator (ASR)
3	V/f control with speed sensor			
4	V/f control with speed sensor and auto torque boost	Vector control	Estimated speed	Speed control with automatic speed regulator (ASR)
6	Vector control for induction motor with speed sensor			
15	Vector control for synchronous motor without speed sensor and pole position sensor			

■ V/f control without slip compensation

Under this control, the inverter controls a motor with the voltage and frequency according to the V/f pattern specified by function codes. This control disables all automatically controlled features such as the slip compensation, so no unpredictable output fluctuation occurs, enabling stable operation with constant output frequency.

■ V/f control with slip compensation

Applying any load to an induction motor causes a rotational slip due to the motor characteristics, decreasing the motor rotation. The inverter's slip compensation function first presumes the slip value of the motor based on the motor torque generated and raises the output frequency to compensate for the decrease in motor rotation. This prevents the motor from decreasing the rotation due to the slip.

That is, this function is effective for improving the motor speed control accuracy.

Function code		Action
P12	Rated slip frequency	Specify the rated slip frequency.
P09	Slip compensation gain for driving	Adjust the slip compensation amount for driving. Slip compensation amount for driving = Rated slip x Slip compensation gain for driving
P11	Slip compensation gain for braking	Adjust the slip compensation amount for braking. Slip compensation amount for braking = Rated slip x Slip compensation gain for braking
P10	Slip compensation response time	Specify the slip compensation response time. Basically, there is no need to modify the setting.

To improve the accuracy of slip compensation, perform auto-tuning.

H68 enables or disables the slip compensation function 1 according to the motor driving conditions.

H68 data	Motor driving conditions		Motor driving frequency zone	
	Accel/Decel	During constant speed	Base frequency or below	Above the base frequency
0	Enable	Enable	Enable	Enable
1	Disable	Enable	Enable	Enable
2	Enable	Enable	Enable	Disable
3	Disable	Enable	Enable	Disable

■ Vector control without speed sensor (dynamic torque vector)

To get the maximal torque out of a motor, this control calculates the motor torque matched to the load applied and uses it to optimize the voltage and current vector output.

When the vector control without speed sensor (dynamic torque vector) is selected, automatically auto torque boost and slip compensation become enabled. This control is effective for improving the system response to external disturbances such as load fluctuations, and the motor speed control accuracy.

Note that the inverter may not respond to a rapid load fluctuation.

 **Note** For slip compensation in case of vector control without speed sensor, constants of motor are used. Therefore, satisfy the following conditions below. If these conditions cannot be satisfied, sufficient control performance may not be obtained.

- A single motor is controlled per inverter.
- The prerequisite is that motor parameter P02, P03, P06 to P13 are accurately set or auto-tuning is performed.
- Under vector control without speed sensor, the capacity of the motor to be controlled must be not less than two ranks lower of the inverter capacity. Otherwise, the inverter may not control the motor due to decrease of the current detection resolution.

■ V/f control with speed sensor

Applying any load to an induction motor causes a rotational slip due to the motor characteristics, decreasing the motor rotation. Under V/f control with speed sensor, the inverter detects the motor rotation using the encoder mounted on the motor shaft and compensates for the decrease in slip frequency by the PI control to match the motor rotation with the reference speed. This improves the motor speed control accuracy.

■ V/f control with speed sensor and auto torque boost

The difference from "V/f control with speed sensor" stated above is to calculate the motor torque that matches to the load applied, and use it to optimize the voltage and current vector output for getting the maximal torque from the motor.

This control is effective for improving the system response to external disturbances such as load fluctuations, and the motor speed control accuracy.

■ Vector control for synchronous motor without speed sensor nor pole position sensor

This control estimates the motor speed based on the inverter's output voltage and current, and uses the estimated speed for speed control. It also decomposes the motor drive current into the exciting and torque current components, and controls each of those components as vectors. No PG (pulse generator) interface card is required. It is possible to obtain the desired response by adjusting the control constants (PI constants) using the speed regulator (PI controller).

 **Note** When changing function code F42 to data 15 " Vector control for synchronous motor without speed sensor nor pole position sensor " by the keypad, then the inverter automatically updates data of F03, F04, F05 and others.

■ **Control parameters which are initialized when the control method F42 is changed**



When control method (F42) is switched between synchronous motor and induction motor, the value of the related function codes are also switched. See the table below.

Function code	Switch F42 between 15 and others	Change P02	H03=2 with F42=0 to 4, 6	H03=2 with F42=15
F03	Y	N	N	N
F04	Y	N	N	Y
F05	Y	N	N	Y
F06	Y	N	N	Y
F10	N	N	N	Y
F11	Y	N	N	Y
F12	Y	N	N	Y
F15	Y	N	N	N
F23	Y	N	N	N
F26	Y	N	N	N
F40 to F41	Y	N	N	N
E50	Y	N	N	N
P01	Y	N	Y	Y
P02	N	N	N	N
P03	Y	Y	Y	Y
P05 to P13	N	Y	Y	Y
P16-P20	N	Y	Y	Y
P30	N	Y	Y	Y
P53	N	Y	Y	Y
P55 to P56	N	Y	Y	Y
P60 to P64	N	Y	Y	Y
P65	N	Y	Y	Y
P74	N	Y	Y	Y
P83	N	Y	Y	Y
P84	N	Y	Y	Y
P85	N	Y	Y	Y
P87 to P89	N	Y	Y	Y
P90	N	Y	Y	Y
P99	Y	N	N	N
H46	N	Y	Y	Y
d01 to d04	Y	N	N	N

Y: Switched N: Not switched

F80**Switching between ND,HD,HND and HHD drive modes**

This function code allows to set the drive mode of the inverter. In case of Solar Pumping application, it is recommended to use HHD or HND modes only because they allow an ambient temperature up to 50°C, which is quite common in Solar Pumping application.

To change the data of function code F80 data, double key operation with "STOP key + /  key" is necessary.

F80 data	Drive mode	Application	Rated current level	Ambient temperature	Overload capability	Maximum output frequency
0	HHD mode	Heavy load	Capable of driving a motor whose capacity is the same as the inverter capacity.	50°C (122°F)	150% 1min, 200% 0.5s	500Hz
1	HND mode	Light load	Capable of driving a motor whose capacity is one rank higher than the inverter capacity.	50°C (122°F)	120% 1 min	500Hz
3	HD mode	Medium load	Capable of driving a motor whose capacity is one rank higher than the inverter capacity.	40°C (104°F)	150% 1 min	500Hz
4	ND mode	Light load	Capable of driving a motor whose capacity is two ranks higher than the inverter capacity.	40°C (104°F)	120% 1 min	120Hz

For the concrete rated current level, refer to "Chapter 7 SPECIFICATIONS." Factory defaults are 0: HHD for Japan and 4: ND for other countries.



When, by changing the mode, the motor capacity becomes 75kW or higher, make sure to connect direct current reactor (DCR) according to the motor capacity. However, it is not necessary when supplying from PV panel.

Failure may occur

ND, HD, HND, and HHD-mode inverters are subject to restrictions on the function code data setting range and internal processing as listed below.

Function code	Name	Remarks
F21	DC braking 1 (Braking level)	Upper limit restriction
F26	Motor sound (Carrier frequency)	Upper limit restriction
F44	Current limiter (Level)	Default setting, setting value
F03	Maximum frequency	Allowed output frequency range
A10	DC braking 2 (Braking level)	Upper limit
J68	Brake Signal Brake-release current	Upper limit

E01 to E05

Terminals [X1] to [X5] function

Related function codes: Terminal E98 [FWD] function

Terminal E99 [REV] function

E01 to E05, E98 and E99 assign commands to general-purpose, programmable, digital input terminals, [X1] to [X5], [FWD], and [REV].

In case of solar pumping application set E98 and E99 to “No function assigned”.

(📖 Function code E98, E99 data = 100)

If tank high level detection digital signal is used please set E01 to “No function assigned”.

(📖 Function code E01 data = 100)

For details on these functions refer to FRENIC Ace User Manual.

CAUTION

- Run commands (e.g., Run forward “FWD”), stop commands (e.g., Coast to a stop “BX”), and frequency change commands can be assigned to digital input terminals. Depending on the state of digital input terminals, modifying a single function code setting may cause abrupt start of operation or significant change of the speed. Ensure safety before modifying the function code settings.

An accident or physical injury may result.

**E20 to E21
E27**

**Terminals [Y1] function to [Y2] function
Terminal [30A/B/C] function (Relay output)**

E20 through E21 and E27 assign output signals to general-purpose, programmable output terminals, [Y1], [Y2] and [30A/B/C]. These function codes can also switch the logic system between normal and negative to define how the inverter interprets the ON or OFF state of each terminal. The factory default setting is normal logic system “Active ON”.

Terminals [Y1] and [Y2] are transistor outputs and terminals [30A/B/C] are contact outputs. In normal logic, if an alarm occurs, the relay will be energized so that [30A] and [30C] will be closed, and [30B] and [30C] opened. In negative logic, the relay will be de-energized so that [30A] and [30C] will be opened, and [30B] and [30C] closed. This may be useful for the implementation of failsafe power systems.

For details on these functions refer to FRENIC Ace User Manual.



Note

- When negative logic is employed, all output signals are active (e.g. an alarm would be recognized) while the inverter is powered OFF. To avoid causing system malfunctions by this, interlock these signals to keep them ON using an external power supply. Furthermore, the validity of these output signals is not guaranteed for approximately 1.5 seconds (for 22 kW or below) or 3 seconds (for 30 kW or above) after power-ON, so introduce such a mechanism that masks them during the transient period.
- Terminals [30A/B/C] use mechanical contacts. They cannot stand frequent ON/OFF switching. Where frequent ON/OFF switching is anticipated use transistor outputs [Y1] and [Y2] instead.

P01**Motor 1 (No. of poles)**

P01 specifies the number of poles of the motor. Enter the value given on the nameplate of the motor. This setting is used to display the motor speed on the LED monitor and to control the speed (refer to E43). The following expression is used for the conversion.

Motor rotational speed (min^{-1}) = $120/\text{No.of poles} \times \text{Frequency (Hz)}$

- Data setting range: 2 to 22 (poles)

P02**Motor 1 (Rated capacity)**

P02 specifies the rated capacity of the motor. Enter the rated value given on the nameplate of the motor.

P02 data	Unit	Function
0.01 to 1000	kW	When P99 (Motor 1 selection) = 0, 4, 20 or 21
	HP	When P99 (Motor 1 selection) = 1

When accessing P02 with the keypad, take into account that the P02 data automatically updates data of P03, P06 through P13, P53 and H46.

P03**Motor 1 (Rated current)**

P03 specifies the rated current of the motor. Enter the rated value given on the nameplate of the motor.

- Data setting range: 0.00 to 2000 (A)

The inverter automatically detects the motor parameters and saves them in its internal memory. Basically, it is not necessary to perform tuning when a Fuji standard motor is used with a standard connection with the inverter.

There are two types of auto-tuning as listed below. Select the appropriate one considering the limitations in your equipment and control mode.

P04 data	Auto-tuning	Action	Motor parameters to be tuned	
0	Disable	---	---	
1	Tune the motor while it is stopped	Tunes while the motor is stopped.	IM	Primary resistance (%R1) (P07) Leakage reactance (%X) (P08) Rated slip frequency (P12) %X correction factors 1 (P53)
			PM	Armature resistance (P60) d-axis inductance (P61) q-axis inductance (P62) Reserved (P84, P88)
2	Tune the motor while it is rotating.	After tuning the motor in a stopped state, retunes it running at 50% of the base frequency.	IM	No-load current (P06) Primary resistance (%R1) (P07) Leakage reactance (%X) (P08) Rated slip frequency (P12) %X correction factor 1 (P53) Magnetic saturation factors 1 to 5 (P16 to P20)
			PM	Armature resistance (P60) d-axis inductance (P61) q-axis inductance (P62) Induced voltage (P63) Reserved (P84, P88)
5	Tune the motor while it is stopped	Tunes while the motor is stopped.	IM	Primary resistance (%R1) (P07) Leakage reactance (%X) (P08)

 For details of auto-tuning, refer to the FRENIC-Ace Instruction Manual, Chapter 4 "TEST RUN PROCEDURE."

 **Note** In any of the following cases, perform auto-tuning since the motor parameters are different from those of Fuji standard motors so that the best performance cannot be obtained under some conditions.

- The motor to be driven is a non-Fuji motor or a non-standard motor.
- Cabling between the motor and the inverter is long (Generally, 20 m (66 ft) or longer).
- A reactor is inserted between the motor and the inverter.

■ Functions whose performance is affected by the motor parameters

Function	Related function codes (representative)
Auto torque boost	F37
Output torque monitor	F31, F35
Load factor monitor	F31, F35
Auto energy saving operation	F37
Torque limit control	F40
Anti-regenerative control (Automatic deceleration)	H69
Auto search	H09
Slip compensation	F42
V/f control with speed sensor and auto torque boost	F42
Droop control	H28
Torque detection	E78 to E81
Brake Signal (Brake-release torque)	J95
Vector control with speed sensor	F42

**P06 to
P08**

Motor 1 (No-load current, %R1 and %X)

P06 through P08 specify no-load current, %R1 and %X, respectively. Obtain the appropriate values from the test report of the motor or by calling the manufacturer of the motor. Performing auto-tuning automatically sets these parameters.

- No-load current: Input the value obtained from the motor manufacturer.
- %R1: Enter the value calculated by the following expression.

$$\%R1 = \frac{R1 + \text{Cable}R1}{V / (\sqrt{3} \times I)} \times 100(\%)$$

R1: Primary resistance of the motor (Ω)

Cable R1: Resistance of the output cable (Ω)

V: Rated voltage of the motor (V)

I: Rated current of the motor (A)

- %X: Enter the value calculated by the following expression.

$$\%X = \frac{X1 + X2 \times XM / (X2 + XM) + \text{Cable}X}{V / (\sqrt{3} \times I)} \times 100(\%)$$

X1: Primary leakage reactance of the motor (Ω)

X2: Secondary leakage reactance of the motor (converted to primary) (Ω)

XM: Exciting reactance of the motor (Ω)

Cable X: Reactance of the output cable (Ω)

V: Rated voltage of the motor (V)

I: Rated current of the motor (A)



For reactance, use the value at the base frequency (F04).

P12**Motor 1 (rated slip frequency)**

P12 specifies rated slip frequency. Obtain the appropriate values from the test report of the motor or by calling the manufacturer of the motor. Performing auto-tuning automatically sets this parameter.

- Rated slip frequency: Convert the value obtained from the motor manufacturer to Hz using the following expression and enter the converted value.



(Note: The motor rated values given on the nameplate sometimes shows a larger value.)

$$\text{Rated slip frequency (Hz)} = \frac{(\text{Synchronous speed} - \text{Rated speed})}{\text{Synchronous speed}} \times \text{Base frequency}$$

 For details about slip compensation control, refer to the description of F42.

H03**Data initialization**

Initialize all function code data to the factory defaults. The motor parameters are also initialized.

To change the H03 data, it is necessary to press the  + /  keys (simultaneous keying).

H03 data	Function
0	Disable initialization (Settings manually made by the user will be retained.)
1	Initialize all function code data to the factory defaults
2	Initialize motor 1 parameters in accordance with F42(Drive control selection 1), P02 (Rated capacity) and P99 (Motor 1 selection)
3	Initialize motor 2 parameters in accordance with A16 (Rated capacity) and A39 (Motor 2 selection)
11	Limited initialization (initialization other than communications function codes): Communication can be continued after initialization.
12	Limited initialization (initialization of customizable logic function U codes only)

- To initialize the motor parameters, set the related function codes as follows.

Step	Item	Data	Function code	
			1st motor	2nd motor
(1)	Motor selection	Selects the motor type	P99	A39
(2)	Motor (rated capacity)	Sets the motor capacity (kW)	P02	A16
(3)	Data initialization	Initialize motor parameters	H03 = 2	H03 = 3
Function code data to be initialized Please refer to the F42 when using PMSM drive (F42=15)			P01, P03, P05 to P20, P30, P53 to P56, P60 to P65, P74, P83 to P90, H46	A15, A17, A20 to A27, A30 to A34, A53 to A56

- Upon completion of the initialization, the H03 data reverts to "0" (factory default).
- If P02/A16 data is set to a value other than the standard nominal applied motor rating, data initialization with H03 internally converts the specified parameters values to the standard nominal applied motor rating (See Table B given on the last page in "5.2 Function code table.").
- Motor parameters to be initialized are for motors listed below under V/f control. When the base frequency, rated voltage, and the number of poles are different from those of the listed motors, or when non-Fuji motors or non-standard motors are used, change the rated current data to that printed on the motor nameplate.

Motor selection		V/f control data
Data = 0 or 4	Fuji standard motors, 8-series	4 poles 200 V/50 Hz, 400 V/50 Hz
Data = 1	HP rating motors	4 poles 230 V/60 Hz, 460 V/60 Hz



When accessing P02 with the keypad, take into account that the P02 data automatically updates data of P03, P06 through P13, P53 and H46. Also, when accessing function code A16 for the 2nd motor, data of related function codes for each are automatically updated.

H06

Cooling fan ON/OFF control

To prolong the service life of the cooling fan and reduce fan noise during running, the cooling fan stops when the temperature inside the inverter drops below a certain level while the inverter stops. However, since frequent switching of the cooling fan shortens its service life, the cooling fan keeps running for at least 10 minutes once started.

H06 specifies whether to keep running the cooling fan all the time or to enable ON/OFF control.

H06 data	Function
0	Disable (Always in operation)
1	Enable (ON/OFF controllable)

■ **Cooling fan in operation -- FAN (E20, E21 and E27, data = 25)**

With the cooling fan ON/OFF control enabled (H06 = 1), this output signal is ON when the cooling fan is in operation, and OFF when it is stopped. This signal can be used to make the cooling system of peripheral equipment interlocked for an ON/OFF control

H11

Deceleration mode

H11 specifies the deceleration mode to be applied when a run command is turned OFF.

H11 data	Action
0	Normal deceleration
1	The inverter immediately shuts down its output, so the motor stops according to the inertia of the motor and machinery (load) and their kinetic energy losses. Use this setting to avoid regeneration when operation command is turned OFF.



When reducing the reference frequency, the inverter decelerates the motor according to the deceleration commands even if H11 = 1 (Coast to a stop).

H72

Main power shutdown detection (Mode selection)

This function monitors the AC input power supply of the inverter to see if the AC input power supply (main circuit power) is established and prevents inverter operation when the main circuit power is not established.

H72 data	Function
0	Disables main circuit power cutoff detection
1	Enables main circuit power cutoff detection

With power supply directly on the DC bus there is no AC input. When the data for H72 is "1," the inverter cannot operate. Change the data for H72 to "0". It is not required to set this parameter for models up to/including FRN0056E2S-2, and for models up to/including FRN0037E2S-4.



For single-phase supply, consult your Fuji Electric representatives.

H111

UPS operation Level

This parameter is used to set the minimum allowed DC link voltage to keep operation.

- Data setting range: 150 to 220 VDC: (200 V class), 340 to 440 VDC: (400 V class)

J01	PID Control (Mode selection)
------------	-------------------------------------

J01 is used to activate the PID control of the inverter. In case of Solar Pumping application please set this function code to 2 (inverse operation). The reason is that in this application when the PID feedback value is higher than the PID set point value the output of the PID controller has to increase the manipulated value (inverter frequency set point) in order to increase the power consumption of the motor, causing a reduction of the PV panel voltage (PID feedback).

J02	PID Control (Remote command)
------------	-------------------------------------

This parameter is used to set the source of the set point value (SV) under PID control. For Solar Pumping application please set to 1, so that the set point value can be given from the Customized Logic program.

J06	PID Control (Feedback filter)
------------	--------------------------------------

J06 specifies the time constant of the filter for feedback signals under PID control. In case of Solar Pumping application the recommended value is 0.0 (s). The reason is that the PID feedback value (DC link voltage/PV panel voltage) should not be filtered to be able to respond rapidly to changes on the PV panel conditions (especially irradiance when changing from cloudy to sunny and opposite).

J59 J60	PID Control (P (Gain) 2) PID Control (I (Integral time) 2)
--------------------------	---

The inverter is able to select between two PID gain sets depending on the relative values of the PID feedback and PID set point.

J59 (P Gain 2) and J60 (Integral time 2) are used to set respectively the proportional gain and integral time of the PID controller when the PID feedback value is higher than the PID set point value. These constants should be set to achieve a slow response of the PID controller in order to avoid that the power drawn from the PV panel is too high when the manipulated value (inverter set point frequency) increases.

U132 U133	PID Control (P (Gain) 1) PID Control (I (Integral time) 1)
----------------------------	---

The inverter is able to select between two PID gain sets depending on the relative values of the PID feedback and PID set point.

U132 (P Gain 1) and U133 (Integral time 1) are used to set respectively the proportional gain and integral time of the PID controller when the PID feedback value is lower than the PID set point value. These constants should be set to achieve a fast response of the PID controller in order to reduce as fast as possible the power drawn from the PV panel.

U128 UA14 UA18 UA23	Tank level detection function (High level) Tank level detection function (High level hysteresis width) Tank level detection function (Signal ON Delay Time) Tank level detection function (Signal OFF Delay Time)
--	--

The inverter can monitor the tank level by an analog signal from an analog sensor connected to terminal 12. The inverter can also detect the tank high level by connecting the signal from a sensor to digital input [X1]. It is possible to use either analog or digital sensor, but not both at the same time. In case of using the analog sensor, if the detected level is higher than the value set in U128 (High level) for a time longer than the time set in UA19 (Signal ON delay time) then the inverter will stop operation, in order to prevent the tank overflow. Also the inverter will activate a digital output programmed to function CL01 (*TANK FULL*; E20, E21 data = 111). If the detected level is lower than the value U128 – UA15 (High level hysteresis width) for a time longer than the time set in UA24 (Signal OFF delay time) then the inverter will resume operation, and will deactivate the above mentioned digital function. In case of connecting the tank high level sensor to digital input [X1], the parameters UA19 (Signal ON delay time) and UA24 (Signal OFF delay time) also apply.

Function code U128 is used to set the tank level to determine that the tank is at high level (full) and function code UA15 is used to set the hysteresis band width of U128. The units of U128 and UA15 are in percentage (%), where 100% means the maximum detectable tank level. Set U128 to 100% to disable the tank level detection by analog signal.

Function code UA19 is used to set the signal ON delay time and function code UA24 is used to set the signal OFF delay time. These delay times are helpful to filter the effects of the water waves inside the tank. The time units of UA19 and UA24 are seconds.

U130	Low power detection function (Low Power level)
UA48	Low power detection function (Signal ON delay time)

The inverter monitors the output power. If the detected level is lower than the value set in U130 (Low Power level) for a time longer than the time set in UA49 (Signal ON delay time) then the inverter will activate a digital output programmed to function CL02 (*LOW POWER*; E20, E21 data = 112). If the detected level is higher than the value set in U130 then it will deactivate the above mentioned digital output.

Function code U130 is used to set the power level to determine the low power condition. The units of U130 are in percentage (%), where 100% means the motor rated power (value set in P02).

Function code UA49 is used to set the Low Power signal ON delay time. The time units of UA49 are seconds.

UA53	Dry pump detection function (Output frequency level)
UA54	Dry pump detection function (Output frequency hysteresis width)
UA68	Dry pump detection function (Motor power level)
UA69	Dry pump detection function (Motor power hysteresis width)
UA73	Dry pump detection function (Signal ON Delay Time)
U124	Dry pump detection function (Enable Dry Pump Alarm)

The inverter monitors the output frequency and the power consumption of the motor (pump). If the output frequency is higher than the value set in parameter UA54 (Output frequency level) and the power consumed by the motor is lower than the value set in parameter UA69 (Motor power level) for a time longer than UA73 (Signal ON delay time) the inverter will determine that the pump is dry (Dry pump state); under these conditions it will activate a digital output programmed to function CL04 (*DRY PUMP*; E20, E21 data = 114). The inverter will determine that the pump is not anymore dry if the output frequency is below the level UA54 – UA55 (Output frequency hysteresis width) or the power consumed by the motor is higher than UA69 + UA70 (Motor power hysteresis width), and will deactivate the digital output programmed to function CL04. If function code U124 (Enable Dry Pump Alarm) is set to “1.00” then under the dry pump conditions the inverter will stop and trip by alarm “OH2”. In the event of that the inverter has tripped by alarm “OH2”, it will stay in this condition until the alarm is reset, keeping activated the digital output programmed to CL04; the alarm state can be reset by pressing the Reset key on the inverter keypad (on that time the digital output will be turned OFF). If the dry pump conditions continue after starting again, the inverter eventually will detect this state again.

Function code UA54 is used to set the output frequency level to detect the dry pump state and UA55 is used to set the hysteresis band width of UA54. The output frequency must be higher than the value set in UA54 to detect the dry pump state. The units of UA54 and UA55 are percentage where 100% means the maximum output frequency (value set in F03).

Function code UA69 is used to set the motor power level to detect the dry pump state and UA70 is used to set the hysteresis band width of UA69. The output power must be lower than the value set in UA69 to detect the dry pump state. The units of UA69 and UA70 are percentage where 100% means the motor rated power (value set in P02).

Function code UA73 is used to set the time delay to detect dry pump state. In other words, both the output frequency must be higher than the value set in UA54 and the output power lower than the value set in UA69 for a time longer than UA73 in order to detect the dry pump state.

Function code U124 is used to enable the alarm “OH2” in case that dry pump state is detected, by setting this function code to 1.00.

U126	PV panel specifications (PV panel open circuit voltage)
U127	PV panel specifications (PV panel MPP voltage)

Function code U126 (PV panel open circuit voltage) is used to set the PV panel open circuit voltage.

Function code U127 (PV panel MPP voltage) is used to set the PV panel MPP voltage.

Both parameters are fundamental for the correct operation of the Solar Pumping inverter functions. The units of both parameters are volts (DC). It is possible to set either the voltage than corresponds to a module or the value that corresponds to the complete solar panel series configuration, but the same criteria must be used for both U126 and U127.

U121	MPP Search (Enable MPP search)
U123	MPP search (Enable manual setting of PV panel voltage set point)
U171	MPP search (Actual PV panel voltage set point)
U135	MPP search (Voltage/PID set point increase/decrease step for MPP search)
UB88	MPP search (Time interval)

The maximum power operating point of the PV panel/s may change during the day due to changes of irradiance and PV panel temperature. By setting to "1.00" function code U121 (Enable MPP search), the MPP search (Maximum Power Point Tracking) function is enabled. When MPP search function is enabled the inverter will change the value of the PV panel voltage set point (function code U171) at periodic intervals, to search the maximum power operating point of the PV panel.

By setting to "1.00" function code U123 (Enable manual setting of the PV panel voltage set point), the manual setting of the PV panel (DC link) voltage set point voltage is enabled. In this case the PV panel voltage must be set manually in function code U171.

Function code U171 (Actual PV panel voltage set point) contains the current PV panel voltage set point value. If U123=0.00 the value of U171 is automatically calculated by the inverter. If U123=1.00 the value of U171 should be set manually. The units of U171 are in percentage (%), where 100% means 500 V in case of -2/-7 inverters and 1000 V in case of -4 inverters.

Function code U135 (Voltage/PID set point increase/decrease step for MPP search) is used to set the PV panel voltage set point increase/decrease for 1 step of the MPP search (MPPT) function. The units of U135 are in percentage (%), where 100% means 500 V in case of -2/-7 inverters and 1000 V in case of -4 inverters.

Function code UB88 (Time interval) is used to set in the time interval to execute the MPP search function since the last execution or since the inverter started operation. The time units of this parameter are minutes.

U172	Measurement at open circuit voltage condition (affected by multiplication factor U127/U126)
-------------	--

Function code U172 does not need to be set. It indicates the voltage measured at inverter stop condition or just before inverter started to operate. The value of U172 is the result of the PV panel open circuit voltage measured (at inverter stop condition) multiplied by the factor U127/U126. The units of this parameter are in percentage (%), where 100% means 500 V in case of -2/-7 inverters and 1000 V in case of -4 inverters.

J15	Sleep function (Sleep frequency)
U134	Sleep function (Power level to keep running)
UD88	Sleep function (Sleep time)

Function code J15 (Sleep frequency) is used to set the sleep frequency level. If the inverter output frequency (motor frequency) is lower than the value set in this function code for a time longer than UD88 (Sleep time), then the inverter will stop due to sleep conditions. The units of this parameter are Hz.

Function code U134 (Power level to keep running) is used to set the power level to keep running. If the inverter output power (motor power) is lower than the value set in this function code for a time longer than UD88 (Sleep time), then the inverter will stop due to sleep conditions. The units of this parameter are percentage (%), where 100% means the value set in function code P02 (motor rated power).

Function code UD88 is used to set the sleep time, in other words, it contains the minimum time that the condition (either frequency or power level) should be kept in order to enter the sleep mode. The time units of this parameter are seconds.

If either of the above conditions is fulfilled the inverter will stop by sleep condition, in other words, it is not required that both conditions are fulfilled simultaneously.

 Do not change the value of function code J17 from factory default value, otherwise it would interfere with the sleep and wake up functions.

U131	Wake up function (DC link voltage level to start)
UD98	Wake up function (time)

Function code U131 (DC link voltage level to start) is used to set the minimum DC link voltage level to start. If the DC link voltage multiplied by the factor U127/U126 is higher than the value set in U131 for a time higher than UD98 (time) then the inverter will resume operation.

Function code UD98 is used to set the wake up time, in other words, it contains the minimum time that the condition (DC link voltage level) should be kept in order to resume operation. The units of this parameter are seconds.

 Do not change the value of function code J17 from factory default value, otherwise it would interfere with the sleep and wake up functions.

U125	Big step detection (Disable)
UI08	Big step detection (Dead time for next action)

These function codes are related to the big step detection function (both step UP and step DOWN). In the event of a sudden change of the PV panel conditions (especially irradiance), the voltage of the PV panel will change suddenly. If this occurs, the inverter detects this situation and changes the PV panel (DC link) voltage set point accordingly.

Function code U125 (Disable) is used to enable or disable the big step detection. If U125 is set to "1.00" the big step detection function is disabled.

Function code UI08 (Dead time for next action) is used to set the dead time between two consecutive actions of the big step detection. The dead time allows the PID controller to settle after a big step action occurs.

UH18	Big step UP detection (Level to detect big step UP)
UH48	Big step UP detection (Time to follow the step UP change)

These function codes are related to the big step UP detection function. In the event that the PV panel (DC link) voltage increases suddenly due to an increase of the solar irradiance, the inverter will increase the PV panel (DC link) voltage set point.

Function code UH18 (Level to detect big step UP) is used to set the voltage level difference between PID set point and PID feedback that triggers the Big step up detection function. In other words, if $PID\ feedback > PID\ set\ point + UH18$ then the big step up function is triggered. The units of UH18 are in percentage (%), where 100% means 500 V in case of -2/-7 inverters and 1000 V in case of -4 inverters.

Function code UH48 (Time to follow the step UP change) is used to set the time that the PID set point follows the PID feedback. The time units of this parameter are seconds.

UH53	Big step DOWN detection (Level to detect big step DOWN)
UH83	Big step DOWN detection (Time delay to follow the step DOWN)
UH88	Big step DOWN detection (Time to follow the step DOWN change)

These function codes are related to the big step DOWN detection function. In the event that the PV panel (DC link) voltage decreases suddenly due to a decrease of the solar irradiance, the inverter will decrease the PV panel (DC link) voltage set point.

Function code UH53 (Level to detect big step DOWN) is used to set the voltage level difference between PID set point and PID feedback that triggers the Big step down detection function. In other words, if PID feedback < PID set point – UH53 for a time longer than UH83 then the big step down function is triggered. The units of UH53 are in percentage (%), where 100% means 500 V in case of -2/-7 inverters and 1000 V in case of -4 inverters.

Function code UH83 (Time delay to follow the step DOWN) is used to set the time delay to trigger the step down function. The time units of this parameter are seconds.

Function code UH88 (Time to follow the step DOWN change) is used to set the time that the PID set point follows the PID feedback. The time units of this parameter are seconds.

U00	Customizable logic (Mode selection)
------------	--

U00 (Mode selection) is used to enable/disable the Solar Pumping application. U00 must be set to 1 in order to run the Solar Pumping application.

U00 data	Function
0	Disable
1	Enable (Solar Pumping application)

The *E_{LL}* alarm will occur when changing U00 from 1 to 0 during operation.

Chapter 6 TROUBLESHOOTING

This chapter describes troubleshooting procedures to be done when the inverter malfunctions or detects an alarm or a light alarm condition. In this chapter, first check whether any alarm code or the "light alarm" indication (*l-al*) is displayed or not, and then proceed to the troubleshooting items.

6.1 Protective Functions

In order to prevent system down or to shorten a downtime, FRENIC-Ace is provided with various protective functions (shown in Table 6-1 below). The protective functions marked with an asterisk (*) in the table are disabled by factory default. Enable them according to your needs. The protective functions include, for example, the "heavy alarm" detection function which, upon detection of an abnormal state, displays the alarm code on the LED monitor and causes the inverter to trip, the "light alarm" detection function which displays the alarm code but lets the inverter continue the current operation, and other warning signal output functions. If any problem arises, understand the protective functions listed below and follow the procedures given in Sections 6.2 and onwards of this Manual or the User Manual for troubleshooting.

Table 6-1 Abnormal States Detectable ("Heavy Alarm" and "Light Alarm" Objects)

Protective function	Description	Related function code
"Heavy alarm" detection	This function detects an abnormal state, displays the corresponding alarm code, and causes the inverter to trip. See Table 6.3-1 "Various failure detections (Heavy failure objects)" for alarm codes. For details of each alarm code, see the corresponding item in the troubleshooting in Section 6.3. The inverter retains the last four alarm codes and their factors together with their running information applied when the alarm occurred, so it can display them.	H98
"Light alarm" detection*	This function detects an abnormal state categorized as a "light alarm," displays <i>l-al</i> and lets the inverter continue the current operation without tripping. Details of light alarms are selectable. Selectable details (codes) are shown in Table 6.4-1 "Various failure detections (Light alarm objects)." See Section 6.4 for the confirming method and releasing method of the light alarms.	H81 H82
Stall prevention	When the output current exceeds the current limiter level (F44) during acceleration/ deceleration or constant speed running, this function decreases the output frequency to avoid an overcurrent trip.	F44
Overload prevention control*	Before the inverter trips due to a cooling fin overheat (<i>Ohl</i>) or inverter overload (<i>Olw</i>), this function decreases the output frequency of the inverter to reduce the load.	H70
Anti-regenerative control*	If regenerative energy returned exceeds the inverter's braking capability, this function automatically increases the deceleration time or controls the output frequency to avoid an overvoltage trip.	H69
Deceleration characteristics* (Improvement of braking performance)	During deceleration, this function increases the motor energy loss and decreases the regenerative energy returned to avoid an overvoltage trip (<i>ov</i>).	H71
Reference loss detection*	This function detects a frequency reference loss (due to a broken wire, etc.), issues the alarm, and continues the inverter operation at the specified frequency.	E65
Automatic lowering of carrier frequency	Before the inverter trips due to an abnormal surrounding temperature or output current, this function automatically lowers the carrier frequency to avoid a trip.	H98
Motor overload early warning*	When the inverter output current has exceeded the specified level, this function issues the "Motor overload early warning" signal before the thermal overload protection function causes the inverter to trip for motor protection (Only for the 1st motor).	E34 E35
Retry*	When the inverter has stopped because of a trip, this function allows the inverter to automatically reset and restart itself. The number of retries and the latency between stop and reset can be specified.	H04 H05
Forced stop*	Upon receipt of the "Force to stop" terminal command STOP, this function interrupts the run and other commands currently applied in order to forcedly decelerate the inverter to a stop state.	H56
Surge protection	This function protects the inverter from a surge voltage between main circuit power lines and the ground.	-
Momentary power failure protection*	<ul style="list-style-type: none"> If a momentary power failure for 15 ms or longer occurs, a protective operation (inverter stop) is activated. When momentary power failure restart is selected, the inverter restarts automatically after voltage restoration within a set-up time (momentary power failure permissible time). 	F14

6.2 Before Proceeding with Troubleshooting

WARNING

- If any of the protective functions has been activated, first remove the cause. Then, after checking that all run commands are set to OFF, release the alarm. If the alarm is released while any run command is set to ON, the inverter may supply the power to the motor, running the motor.

Injury may occur.

- Even though the inverter has interrupted power to the motor, if the voltage is applied to the main circuit input terminals L1/R, L2/S, L3/T, L1/L and L2/N, voltage may be output to inverter output terminals U, V, and W.
- Turn OFF the power and wait for at least five minutes for inverters with a capacity of FRN0012E2■-7□ / FRN0115E2■-2□ / FRN0072E2■-4□ or below, or at least ten minutes for inverters with a capacity of FRN0085E2■-4□ or above. Make sure that the LED monitor or charging lamp are turned OFF. Further, make sure, using a multimeter or a similar instrument, that the DC intermediate circuit voltage between the terminals P (+) and N (-) has dropped to the safe level (+25 VDC or below).

Electric shock may occur.

Follow the procedure below to solve problems.

- (1) Is wire connection correct?
See Chapter 2 "2.2.1 Basic connection diagram."
- (2) Check whether an alarm code or the "light alarm" indication (*I-aI*) is displayed on the LED monitor, then refer to the indicated Section of the User Manual
 - When an alarm code (excluding light alarms) is displayed To Section 6.3
 - If the "Light Alarm" Indication (*I-aI*) Appears on the LED Monitor To Section 6.4
 - When codes other than alarm codes and light alarm indication (*I-aI*) are displayed To Section 6.5

6.3 If an Alarm Code Appears on the LED Monitor

6.3.1 Alarm code list

When an alarm is detected, check the alarm code displayed on 7-segment LED of keypad.

When one alarm code has plural factors, alarm subcodes are provided to make it easy to identify causes. When a factor is one, the alarm subcode is displayed as "-" and described as "-."

* See (Chapter 3 "3.4.6 Reading alarm information") for the method to check the alarm codes.

* With regard to alarm details having alarm subcodes name "For manufacturer", inform the alarm subcodes, too, when contacting Fuji Electric or requesting an inverter repair.

Table 6.3-1 Various failure detections (Heavy failure objects)

Alarm code	Alarm code name	Heavy failure object	Light alarm selectable	Retry object	Alarm subcode*	Alarm subcode name
<i>Cof</i>	PID feedback wire break	Y	Y	-	-	-
<i>DbA</i>	Braking transistor broken	Y	-	-	-	-
<i>Dbh</i>	Braking resistor overheat (FRN0115E2■-2□ or below / FRN0072E2■-4□ or below)	Y	Y	Y	0	DB resistor overheat
					1	For manufacturer
<i>Ecf</i>	EN circuit failure	Y	-	-	10	ASIC alarm for functional safety
					3000	Erroneous detection of STO input
					Other than above	For manufacturer
<i>Ecl</i>	Customizable logic failure	Y	-	-	-	-
<i>Ef</i>	Ground fault (FRN0085E2■-4□ or above)	Y	-	-	-	-
<i>er1</i>	Memory error	Y	-	-	1 to 16	For manufacturer
<i>er2</i>	Keypad communications error	Y	-	-	1 to 2	For manufacturer
<i>er3</i>	CPU error	Y	-	-	1 to 9000	For manufacturer
<i>er4</i>	Option communications error	Y	Y	-	1	For manufacturer
<i>er5</i>	Option error	Y	Y	-	0	Time-out
					1 to 10	For manufacturer
<i>er6</i>	Operation error	Y	-	-	1	STOP key priority/forced stop (STOP terminal)
					2	Start check function
					3	Start check function (when operation is permitted)
					4	Start check function (when reset is turned on)
					5	Start check function (when the power recovers in powering on)
					6	Start check function (TP connection)
					8 to 14	For manufacturer

Continuation of Table 6.3-1

Alarm code	Alarm code name	Heavy failure object	Light alarm selectable	Retry object	Alarm subcode*	Alarm subcode name
<i>er7</i>	Tuning error	Y	-	-	7	Operation command OFF during motor tuning
					8	Forced stop during motor tuning
					9	BX command during motor tuning
					10	Hardware current limit during motor tuning
					11	Occurrence of low voltage (LV) during motor tuning
					12	Failure due to prevention of reverse rotation during motor tuning
					13	Over upper limit frequency during motor tuning
					14	Switching to commercial power during motor tuning
					15	Occurrence of alarm during motor tuning
					16	Change of run command source during motor tuning
					18	Over acceleration time during motor tuning
					24	EN terminal failure during motor tuning
					Other than above	For manufacturer
<i>er8</i>	RS-485 communications error (Communication port 1)	Y	Y	-	-	-
<i>Erd</i>	Step-out detection	Y	-	-	5001 to 5008	For manufacturer
<i>Ere</i>	Speed inconsistency/ excessive speed deviation	Y	Y	-	1	Signs of speed command and speed detection are inconsistent.
					3	In the case of excessive speed deviation ($ \text{detected speed} > \text{speed command} $)
					5	Detected speed remains 0Hz irrespective of speed command.
					7	In the case of excessive speed deviation ($ \text{detected speed} < \text{speed command} $)
<i>Erf</i>	Data saving error during undervoltage	Y	-	-	-	-
<i>Erh</i>	Hardware error	Y	-	-	-	-
<i>Ero</i>	Positioning control error	Y	Y	-	1 to 5	For manufacturer
<i>Erp</i>	RS-485 communications error (Communication port 2)	Y	Y	-	-	-
<i>Err</i>	Simulated failure	Y	-	-	-	-
<i>Ert</i>	CAN communications failure	Y	-	-	1 to 2	For manufacturer
<i>fUs</i>	DC fuse-blowing	Y	-	-	-	-
<i>Lin</i>	Input phase loss	Y	-	-	1-2	For manufacturer
<i>Lu</i>	Undervoltage	Y	-	-	1	Occurrence of low voltage during gate ON (F14=0)
					2	Timer time and run command ON during low voltage (F14=0, 2)
					3	LV trip on power recovery from a momentary power failure (F14=1)
					4 to 5	For manufacturer

Continuation of Table 6.3-1

Alarm code	Alarm code name	Heavy failure object	Light alarm selectable	Retry object	Alarm subcode*	Alarm subcode name
<i>0c1</i>	Instantaneous overcurrent	Y	-	Y	1 to 5001	For manufacturer
<i>0c2</i>						
<i>0c3</i>						
<i>0h1</i>	Cooling fin overheat	Y	Y	Y	6	Detection of fan stop
					Other than above	For manufacturer
<i>0h2</i>	External alarm	Y	Y	-	-	-
<i>0h3</i>	Inverter internal overheat	Y	Y	Y	0	Internal air overheat
					1	Charging resistor overheat
					Other than above	For manufacturer
<i>0h4</i>	Motor protection (PTC thermistor)	Y	-	Y	-	-
<i>0h6</i>	Charging resistor overheat	Y	Y	Y	-	-
<i>0l1</i>	Motor 1 overload	Y	Y	Y	-	-
<i>0l2</i>	Motor 2 overload	Y	Y	Y	-	-
<i>0lu</i>	Inverter overload	Y	-	Y	1	IGBT protection
					2	Inverter overload
					10	For manufacturer
<i>0p1</i>	Output phase-failure detection	Y	-	-	1 to 10	For manufacturer
<i>0s</i>	Overspeed protection	Y	-	-	-	-
<i>0u1</i>	Overvoltage	Y	-	Y	1 to 12	For manufacturer
<i>0u2</i>						
<i>0u3</i>						
<i>pbf</i>	Charger circuit fault (FRN0203E2■-4□ or above)	Y	-	-	1 to 2	For manufacturer
<i>pg</i>	PG wire break	Y	-	-	10 to 20	For manufacturer
<i>cnT</i>	Inverter life (Number of startups)	-	Y	-	-	-
<i>fal</i>	Detect DC fan lock	-	Y	-	-	-
<i>lif</i>	Lifetime alarm	-	Y	-	-	-
<i>0h</i>	Cooling fin overheat early warning	-	Y	-	-	-
<i>0l</i>	Overload early warning	-	Y	-	-	-
<i>pid</i>	PID alarm output	-	Y	-	-	-
<i>pTc</i>	PTC thermistor activated	-	Y	-	-	-
<i>ref</i>	Reference command loss detected	-	Y	-	-	-
<i>rTe</i>	Machine life (Cumulative motor running hours)	-	Y	-	-	-
<i>uTl</i>	Low torque detection	-	Y	-	-	-

- NB) • If a control power supply voltage drops to such a level that the operation of the inverter control circuit cannot be maintained, all protective functions are automatically reset.
- By OFF → ON operation of  key or X terminal (assigned to RST), the protection stop state can be released. In a state that an alarm cause is not removed, however, resetting operation is not effective.
 - If two or more alarms are occurring, the resetting operation remains ineffective until all the alarm causes are removed. Alarm factors not removed can be checked from the keypad.
 - When assigned to light alarms, "30A/B/C" do not change.

6.3.2 Causes, checks and measures of alarms

This chapter describes how to proceed in case of specific alarms. For alarms not mentioned in this manual please refer to the User Manual.

[1] *ecf* EN circuit failure

Phenomena Enable circuit state was diagnosed and a circuit failure was detected.

Possible Causes	Check and Measures
(1) Contact defect on control terminal board [Subcode: 10]	Confirm that the control terminal board is firmly mounted on the inverter body. ➔ Alarm is released by turning on again.
(2) Enable circuit logic failure [Subcode: 3000]	Confirm that outputs from safety switch etc. are inputted by the same logic (High/High or Low/Low) with EN1 terminal/EN2 terminal. ➔ Alarm is released by turning on again.
(3) A failure (single failure) of enable circuit (safety stop circuit) was detected.	If the circuit failure is not removable by the procedures above, the inverter is out of order. ➔ Contact your Fuji Electric representative.

[2] *ec1* Customizable logic failure

Phenomena A setting failure of customizable logic was detected.

Possible Causes	Check and Measures
(1) Setting of the selection of customizable logic operation was changed during operation.	Check whether the selection (Function code U00) of customizable logic operation is changed during operation. ➔ Do not change the selection of customizable logic operation during operation to prevent a danger.

[3] *er7* Tuning error

Phenomena Auto-tuning failed.

Possible Causes	Check and Measures
(1) A phase was missing in the connection between the inverter and the motor.	➔ Properly connect the motor to the inverter.
(2) V/f or the rated current of the motor was not properly set.	Check whether the data of function codes (F04*, F05*, H50, H51, H52, H53, H65, H66, P02*, P03*) agree with the motor modes.
(3) The wiring length between the inverter and the motor was too long.	Check whether the wiring length between the inverter and the motor exceeds 50 m. Inverters with a small capacity are greatly affected by the wiring length. ➔ Review, and if necessary, change the layout of the inverter and the motor to shorten the connection wire. Alternatively, minimize the wiring length without changing the layout. ➔ Disable both auto-tuning and auto-torque boost (set data of F37* to "1").
(4) The rated capacity of the motor was significantly different from that of the inverter.	Check whether the rated capacity of the motor is three or more ranks lower, or two or more ranks higher than that of the inverter. ➔ Replace the inverter with one with an appropriate capacity. ➔ Set motor constants (P06*, P07*, P08*) manually. ➔ Disable both auto-tuning and auto-torque boost (set data of F37* to "1").
(5) The motor was a special type such as a high-speed motor.	➔ Disable both auto-tuning and auto-torque boost (set data of F37* to "1").
(6) Tuning (P04*=2) operation was performed of rotating a motor in a state that brake is applied to the motor.	➔ Specify the tuning that does not involve the motor rotation (P04* = 1). ➔ Perform the tuning (P04*=2) with the motor brake released.

[4] *erh* Hardware error

Phenomena Faulty contact of the connector connecting the control and power printed circuit boards was detected.

Possible Causes	Check and Measures
(1) The control printed circuit board is misconnected to the power printed circuit board.	It is necessary to replace the power or control printed circuit board. → Contact your Fuji Electric representative.

[5] *ocn* Instantaneous overcurrent

Phenomena The inverter momentary output current exceeded the overcurrent level.

oc1 Overcurrent occurred during acceleration.

oc2 Overcurrent occurred during deceleration.

oc3 Overcurrent occurred during running at constant speed.

Possible Causes	Check and Measures
(1) The inverter output lines were short-circuited.	Disconnect the wiring from the inverter output terminals (U, V and W) and measure the interphase resistance of the motor wiring. Check if the resistance is too low. → Remove the short-circuited part (including replacement of the wires, contactor, terminals and motor).
(2) Ground faults have occurred at the inverter output lines.	Disconnect the wiring from the output terminals (U, V, and W) and perform a Megger test. → Remove the grounded parts (including replacement of the wires, contactor terminals and motor).
(3) Overload.	Measure the motor current with a measuring device to trace the current trend. Then, use this data to judge if the trend is over the calculated load value for your system design. → If the load is too heavy, reduce it or increase the inverter capacity. Trace the current trend and check if there are any sudden changes in the current. → If there are any sudden changes, make the load fluctuation smaller or increase the inverter capacity. → Enable instantaneous overcurrent limiting (H12 = 1).
(4) Excessive torque boost specified. The manual torque boost is set if F37* = 0, 1, 3, or 4.	Check whether decreasing the torque boost (F09*) decreases the output current but does not stall the motor. → If no stall occurs, decrease the torque boost (F09*).
(5) The specified acceleration/ deceleration time was too short.	Check that the motor generates enough torque required during acceleration/deceleration. That torque is calculated from the moment of inertia of the load and the acceleration/deceleration times. → Increase the acceleration/deceleration times (F07, F08, E10 through E15, and H56). → Enable the current limiter (F43) and torque limiter (F40, F41, E16, and E17). → Increase the inverter capacity.
(6) Malfunction caused by noise.	Check if appropriate noise control measures have been implemented (e.g., correct grounding and routing of control and main circuit wires). → Implement noise control measures. For details, refer to Appendix A. → Enable the retry function (H04). → Connect a surge absorber to magnetic contactor's coils or other solenoids (if any) causing noise.
(7) Motor is idling at start-up.	When the motor is idling at high speed, an excessive current flow during start-up. → Enable auto search (H09/d67).

[6] Oh1 Cooling fin overheat

Phenomena Temperature around heat sink has risen abnormally.

Possible Causes	Check and Measures
(1) The surrounding temperature exceeded the inverter's mode limit.	Measure the surrounding temperature. ➔ Lower the temperature (e.g., ventilate the panel where the inverter is mounted).
(2) Ventilation paths are blocked.	Check if there is sufficient clearance around the inverter. ➔ Change the mounting place to ensure the clearance.
	Check if the fin is not clogged. ➔ Clean the fin.
(3) Cooling fan's airflow volume decreased due to the service life expired or failure.	Check the cumulative run time of the cooling fan. See Chapter 3 "3.4.5 Reading maintenance information." ➔ Replace the cooling fan.
[Subcode:6]	Visually check that the cooling fan rotates normally. ➔ Replace the cooling fan.
(4) Overload.	Measure the inverter output current. ➔ Reduce the load. Reduce the load before reaching an overload using cooling fin overheat forecast (E01-E05)/overload forecast (E34). ➔ Decrease the motor sound (Carrier frequency (F26)). ➔ Enable overload prevention control (H70).

[7] Oh2 External alarm

Phenomena External alarm was inputted (THR).
(when the "Enable external alarm" signal THR has been assigned to any of digital input terminals)

Dry pump detection.
(when the parameter for activation of alarm in case of dry pump detection has been set to 1.00)

Possible Causes	Check and Measures
(1) An alarm function of external equipment was activated.	Check the operation of external equipment. ➔ Remove the cause of the alarm that occurred.
(2) Wrong connection or poor contact in external alarm signal wiring.	Check if the external alarm signal wiring is correctly connected to the terminal to which the "external alarm" has been assigned (Any of E01 to E05, E98, and E99 should be set to "9"). ➔ Connect the external alarm signal wire correctly.
(3) Incorrect setting of function code data.	Check whether an "external alarm" is assigned to a terminal not used yet among E01 to E05, E98, E99. ➔ Correct the assignment.
	Check whether the logic of [THR] set up at E01 to E05, E98, E99 agrees with that (positive/negative) of external signals. ➔ Ensure the matching of the logic.

[8] Oh3 Inverter internal overheat

Phenomena Temperature inside the inverter has exceeded the allowable limit.

Possible Causes	Check and Measures
(1) The surrounding temperature exceeded the inverter's mode limit. [Subcode:0]	Measure the surrounding temperature. ➔ Lower the temperature around the inverter (e.g., ventilate the panel where the inverter is mounted).

[9] Oh4 Motor protection (PTC thermistor)

Phenomena Temperature of the motor has risen abnormally.

Possible Causes	Check and Measures
(1) The temperature around the motor exceeded the motor's mode range.	Measure the surrounding temperature. → Lower the temperature around the motor.
(2) Cooling system for the motor is defective.	Check if the cooling system of the motor is operating normally. → Repair or replace the cooling system of the motor.
(3) Overload.	Measure the inverter output current. → Reduce the load (e.g. Use the overload early warning (E34) and reduce the load before the overload protection is activated.). In winter, the load tends to increase. → Lower the temperature around the motor. → Increase the Carrier frequency (function code F26).
(4) The activation level (H27) of the PTC thermistor for motor overheat protection was set inadequately.	Check the PTC thermistor modes and recalculate the detection voltage. → Modify the data of function code H27.
(5) The setting of the PTC thermistor is not adequate.	Check thermistor Mode selection (H26, E59) and the changeover switches (SW3, SW4) of terminal [C1]. → Change the settings to E59=0, H26=1, and set SW3 to C1 side and SW4 to PTC side.
(6) Excessive torque boost specified (F09*)	Check whether decreasing the torque boost (F09*) does not stall the motor. → If no stall occurs, decrease the F09* data.
(7) The V/f pattern did not match the motor.	Check if the base frequency (F04*) and the rated voltage at base frequency (F05*) match the rated values on the motor's nameplate. → Match the function code data with the values on the motor's nameplate.
(8) Incorrect setting of function code data.	Although PTC thermistor is not used, the thermistor Mode selection (H26) is set to the operation state. → Set the H26 data to "0" (Disable).



6.4 If the "Light Alarm" Indication (*I-aI*) Appears on the LED Monitor

If the inverter detects a minor abnormal state, it can continue the current operation without tripping while displaying the "light alarm" indication (*I-aI*) on the LED monitor. In addition to the indication *I-aI*, the inverter blinks the KEYPAD CONTROL LED and outputs the "light alarm" signal L-ALM to a digital output terminal to alert the peripheral equipment to the occurrence of a light alarm. To use the L-ALM signal, it is necessary to assign this signal to any of the digital output terminals by setting any of function codes E20 to E21 and E27 to "98.")

Function codes H81 and H82 specify which alarms should be categorized as "light alarm." Selectable factors (codes) are the codes of light alarm objects shown in Table 6.3-1.



To display the "light alarm" factor and escape from the light alarm state, follow the instructions below.

■ Check method of light alarm factors

- 1) Press the  key to enter Programming mode.
 - 2) Check the light alarm factor in *5_36* (Light alarm factor (latest)) under Menu #5 "Maintenance Information" in Programming mode. The light alarm factor is displayed in alarm codes. See Table 6.3-1 for code details.
-  See Chapter 3 "3.4.5 Reading maintenance information" for the details of screen transition in the "Maintenance Information." It is possible to display the factors of most recent 3 light alarms in *5_37* (Light alarm factor (last)) to *5_39* (Light alarm factor (3rd last)).

■ Switching the LED monitor from the light alarm to normal display

If it is necessary to return the LED monitor to the normal display state (showing the running status such as reference frequency) temporarily before removing the light alarm factor because it takes a long time to remove the light alarm factor, for example, follow the steps below.

- 1) Press the  key to return the LED monitor to the light alarm indication (*I-aI*).
- 2) Press  key in a state of light alarm display (*I-aI*). Keypad display returns from light alarm display (*I-aI*) to monitor display (including frequency display) in the ordinary running state. KEYPAD CONTROL LED continues blinking, though.

■ Release method of light alarms

- 1) See function codes (H81, H82) corresponding to light alarm factors (codes) checked in the Maintenance Information to remove the occurrence factors of light alarms.
- 2) To return the LED monitor from the *I-aI* display to the normal display state (showing the running status such as reference frequency), press the  key in Running mode.





If the light alarm factor(s) has been successfully removed in step 1) above, the KEYPAD CONTROL LED stops blinking and the digital output L-ALM also goes OFF. If any light alarm factor persists (e.g., detecting a DC fan lock), the KEYPAD CONTROL LED continues blinking and the L-ALM remains ON.

6.5 Problems with inverter settings

[1] Nothing appears on the LED monitor

Possible Causes	Check and Measures
(1) No power (neither main power nor auxiliary control power) is supplied to the inverter.	<p>Check the input voltage and interphase voltage unbalance.</p> <ul style="list-style-type: none"> ➔ Switch on the molded-case circuit breaker, the earth-leakage circuit breaker (with overcurrent protective function) or the magnetic contactor. ➔ Check for voltage drop, phase loss, poor connections, or poor contacts and fix them if necessary.
(2) The power for the control PCB did not reach a sufficiently high level.	<p>In case of supplying the inverter through the AC input terminals (L1 to L3), check if the shorting bar has been removed between terminals P1 and P(+) or if there is a poor contact between the shorting bar and those terminals.</p> <ul style="list-style-type: none"> ➔ Mount a shorting bar or a DC reactor between terminals P1 and P(+). In case of poor contact, tighten the screws.

[6] Data of function codes cannot be changed

Possible Causes	Check and Measures
(1) An attempt was made to change function code data that cannot be changed when the inverter is running.	Check if the inverter is running with Menu "Drive Monitoring" using the keypad and then confirm whether the data of the function codes can be changed when the motor is running by referring to the function code tables. → Stop the motor then change the data of the function codes.
(2) The data of the function codes is protected.	Check the data of function code F00 (Data protection). → Change the data of F00 from a data protection state (F00=1 or 3) to a data changeable state (F00=0 or 2).
(3) The WE-KP terminal command ("Enable data change with keypad") is not entered, though it has been assigned to a digital input terminal.	Check the data of the function codes (E01-E05, E98, E99), and check the input state by using "I/O Checking" from the Menu on the keypad. → Input a WE-KP command through a digital input terminal.
(4) The  key was not pressed.	Check whether  key was pressed after changing the data of the function codes. → Press  key after changing the data. Check that <i>SAFE</i> is displayed on the LED monitor.
(5) The data of the function codes F02, E01-E05, E98, E99 are not changeable.	Either one of the FWD and REV terminal commands is turned ON. → Turn OFF both FWD and REV.
(6) The function code(s) to be changed does not appear.	If Menu #0 "Quick Setup" ($Q.FnL$) is selected, only the particular function codes appear. → Call the menu of $!F_{..}$ to $!Y_{..}$ by pressing  key from the quick setup ($Q.FnL$) state on the Menu to display the intended function code and to change the value. (See Chapter 3 Section 3.4 Table 3.4-1 "Menus Available in Programming Mode" for the details.)

[7] Function code data are not changeable (change from link functions)

Possible Causes	Check and Measures
(1) An attempt was made to change function code data that cannot be changed when the inverter is running.	Check if the inverter is running with Menu "Drive Monitoring" using the keypad and then confirm whether the data of the function codes can be changed when the motor is running by referring to the function code tables. → Stop the motor then change the data of the function codes.
(2) The setting of the function code y33 (Built-in CAN communication:Operation selection) is wrong.	Check whether the setting of the function code y33 (Built-in CAN communication:Operation selection) is correct. → Set y33 correctly.
(3) The data of the function code F02 is not changeable.	Either one of the FWD and REV terminal commands is turned ON. → Turn OFF both FWD and REV.

Chapter 7 SPECIFICATIONS

This chapter describes the power circuit input and output ratings and basic constructive specifications of FRENIC Ace standard model.

7.1 Three phase 400V class series (standard model)

Items		Specifications								
Type (FRN E2S-4)		0002	0004	0006	0007	0012	0022	0029	0037	
Nominal applied motor [kW] ¹	HND	0,75	1,1	2,2	3,0 ⁹	5,5 ⁹	7,5	11	15	
	HHD	0,4	0,75	1,5	2,2	3,7	5,5	7,5	11	
Output ratings	Rated capacity [kVA] ²	HND	1,4	2,6	3,8	4,8 ⁹	8,5 ⁹	13	18	24
		HHD	1,1	1,9	3,2	4,2	6,9	9,9	14	18
	Rated voltage [V] ³	Three-phase 380 to 480V (With AVR)								
	Rated current [A] ⁴	HND	1,8	3,4	5,0	6,3 ⁹	11,1 ⁹	17,5	23	31
		HHD	1,5	2,5	4,2	5,5	9,0	13	18	24
Overload capability	HND	120% of nominal current for 1min								
	HHD	150% of nominal current for 1min or 200% of nominal current for 0.5s								
AC input ratings	Main power supply	Three-phase 380 to 480V, 50/60Hz								
	Voltage/frequency variations	Voltage: +10 to -15% (Voltage unbalance:2% or less ⁸ , Frequency: +5 to -5%)								
	Rated current without DCR ⁵ [A]	HND	2,7	3,9	7,3	11,3 ⁹	16,8 ⁹	23,2	33,0	43,8
		HHD	1,7	3,1	5,9	8,2	13,0	17,3	23,2	33,0
	Rated current with DCR ⁵ [A]	HND	1,5	2,1	4,2	5,8 ⁹	10,1 ⁹	14,4	21,1	28,8
		HHD	0,85	1,6	3,0	4,4	7,3	10,6	14,4	21,1
Required power supply capacity ⁶ [kVA]	HND	1,1	1,5	3,0	4,1 ⁹	7,0 ⁹	10	15	20	
	HHD	0,6	1,2	2,1	3,1	5,1	7,3	10	15	
DC	Voltage supply range	240 to 750 V								
DC reactor (DCR)	HND	Option								
	HHD	Option								
Enclosure (IEC60529)		IP20, UL open type								
Cooling method		Natural cooling			Fan cooling					
Mass [kg]		1,2	1,5	1,5	1,6	1,9	5,0	5,0	8,0	

Items		Specifications								
Type (FRN E2S-4)		0044	0059	0072	0085	0105	0139	0168	0203	
Nominal applied motor ¹ [kW]	HND	18,5	22	30	37	45	55	75	90	
	HHD	15	18,5	22	30	37	45	55	75	
Output ratings	Rated capacity[kVA] ²	HND	29	34	46	57	69	85	114	134
		HHD	23	30	34	46	57	69	85	114
	Rated voltage[V] ³	Three-phase 380 to 480V (With AVR)								
	Rated current [A] ⁴	HND	38	45	60	75	91	112	150	176
		HHD	30	39	45	60	75	91	112	150
Overload capability	HND	120% of nominal current for 1min								
	HHD	150% of nominal current for 1min or 200% of nominal current for 0.5s								
AC input ratings	Main power supply	Three-phase 380 to 480V, 50/60Hz							Three-phase 380 to 440V, 50Hz Three-phase 380 to 480V, 60Hz	
	Voltage/frequency variations	Voltage: +10 to -15% (Voltage unbalance:2% or less ⁸ , Frequency: +5 to -5%)								
	Rated current without DCR ⁵ [A]	HND	52,3	60,6	77,9	94,3	114	140	—	—
		HHD	43,8	52,3	60,6	77,9	94,3	114	140	—
	Rated current with DCR ⁵ [A]	HND	35,5	42,2	57,0	68,5	83,2	102	138	164
		HHD	28,8	35,5	42,2	57,0	68,5	83,2	102	138
Required power supply capacity ⁶ [kVA]	HND	25	29	39	47	58	71	96	114	
	HHD	20	25	29	39	47	58	71	96	
DC	Voltage supply range	240 to 750 V	360 to 750V							
DC reactor(DCR)	HND	Option						Must be used		
	HHD	Option						Must be used		
Enclosure (IEC60529)		IP20, UL open type				IP00, UL open type				
Cooling method		Fan cooling								
Mass [kg]		9,0	9,5	10	25	26	30	33	40	

Items		Specifications								
Type (FRN___E2S-4_)		0240	0290	0361	0415	0520	0590			
Nominal applied motor ^{*1} [kW]	HND	110	132	160	200	220	280			
	HHD	90	110	132	160	200	220			
Output ratings	Rated capacity[kVA] ^{*2}	HND	160	193	232	287	316	396		
		HHD	134	160	193	232	287	316		
	Rated voltage[V] ^{*3}	Three-phase 380 to 480V (With AVR)								
	Rated current [A] ^{*4}	HND	210	253	304	377	415	520		
		HHD	176	210	253	304	377	415		
Overload capability	HND	120% of nominal current for 1min								
	HHD	150% of nominal current for 1min or 200% of nominal current for 0.5s								
AC input ratings	Main power supply	Three-phase 380 to 440V, 50Hz ^{*10} Three-phase 380 to 480V, 60Hz								
	Voltage/frequency variations	Voltage: +10 to -15%(Voltage unbalance:2% or less ^{*8} , Frequency: +5 to -5%)								
	Rated current without DCR ^{*5} [A]	HND	—	—	—	—	—	—		
		HHD	—	—	—	—	—	—		
	Rated current with DCR ^{*5} [A]	HND	201	238	286	357	390	500		
		HHD	164	201	238	286	357	390		
Required power supply capacity ^{*6} [kVA]	HND	140	165	199	248	271	347			
	HHD	114	140	165	199	248	271			
DC	Voltage supply range	360 to 750 V								
DC reactor(DCR)	HND	Must be used								
	HHD	Must be used								
Enclosure (IEC60529)		IP00, UL open type								
Cooling method		Fan cooling								
Mass [kg]		62	63	95	96	130	140			

*1 Fuji 4-pole standard motor. At the selection of the inverter rating, consider not only the rating capacity(kW) is enough but also inverter output current is larger than selected the motor's nominal current.

*2 Rated capacity is calculated by assuming the output rated voltage as 440 V.

*3 The output voltage cannot exceed the power supply voltage.

*4 When the carrier frequency (F26) is set to below value or higher, it is necessary to derate the inverter nominal current.

HHD . . . 5.5~55kW : 10kHz, 75kW or above type of capacity : 6kHz

HND . . . 5.5~18.5kW : 10kHz, 22~55kW : 6kHz, 75kW or above type of capacity : 4kHz

HD,ND . . . 5.5~75kW or above type of capacity : 4kHz

HHD spec. . . . type 0002 to 0012 : 8kHz, type 0022 to 0168 : 10kHz, type 0203 to 0590 : 6kHz

HND spec. . . . type 0002 to 0012 : 8kHz, type 0022 to 0059 : 10kHz, type 0072 to 0168 : 6kHz, type 0203 to 0590 : 4kHz

HD,ND spec. . . . All type : 4kHz

The rated output current at HD/ND spec. is decreased 2% for every 1 °C (1.8 °F) when ambient temperature is +40°C (+104 °F) or more.

*5 The value is calculated assuming that the inverter is connected with a power supply with the capacity of 500 kVA

(or 10 times the inverter capacity if the inverter capacity exceeds 50 kVA) and %X is 5%.

Be sure to use the DCR when applicable motor capacity is 75kW or above.

*6 Obtained when a DC reactor (DCR) is used.

*7 Average braking torque for the motor running alone. (It varies with the efficiency of the motor.)

*8 Voltage unbalance (%)=(Max. voltage (V) - Min. voltage (V))/Three -phase average voltage (V) × 67 (IEC 61800 - 3)

If this value is 2 to 3%, use an optional AC reactor (ACR).

*9 HND spec. of the type 0007 and 0012: allowable ambient temperature 40 °C (+104 °F) or less.

*10 The 400 V class with type 0203 or above is equipped with a set of switching connectors (male) which should be configured according to the power source voltage and frequency.

7.2 Single phase 200V class series (standard model)

Items		Specifications						
Type (FRN E2S-7_)		0001	0002	0003	0005	0008	0011	
Nominal applied motor [kW] ¹	HND	0,2	0,4	0,75	-	2,2	3,0	
	HHD	0,1	0,2	0,4	0,75	1,5	2,2	
Nominal applied motor [kW] ¹	HHD	0,1	0,2	0,4	0,75	1,5	2,2	
Output ratings	Rated capacity[kVA] ²	HHD	0,3	0,6	1,1	1,9	3,0	4,2
	Rated voltage[V] ³	Three-phase 200 to 240V (With AVR)						
	Rated current [A] ⁴	HHD	0,8	1,6	3,0	5,0	8,0	11
	Overload capability	HHD	150% of nominal current for 1min or 200% of nominal current for 0.5s					
AC input ratings	Main power supply	Single-phase 200 to 240V, 50/60Hz						
	Voltage/frequency variations	Voltage: +10 to -10% Frequency: +5 to -5%						
	Rated current without DCR [A] ⁵	HND	2,9	4,3	8,8	-	24,7	32,8
		HHD	1,8	3,3	5,4	9,7	16,4	24,8
	Rated current with DCR [A] ⁵	HND	2,0	3,5	6,4	-	17,5	25,3
		HHD	1,1	2,0	3,5	6,4	11,6	17,5
Required power supply capacity [kVA] ⁶	HND	0,4	0,7	1,3	-	3,5	5,1	
	HHD	0,3	0,4	0,7	1,3	2,4	3,5	
DC	Voltage supply range	150 to 375 V						
DC reactor(DCR)	HND	Option						
	HHD	Option						
Enclosure (IEC60529)	IP20, UL open type							
Cooling method	Natural cooling				Fan cooling			
Mass [kg]		0,5	0,5	0,6	0,9	1,6	1,8	
*1 Fuji 4-pole standard motor. At the selection of the inverter rating, consider not only the rating capacity(kW) is enough but also inverter output current is larger than selected the motor's nominal current.								
*2 Rated capacity is calculated by assuming the output rated voltage as 220 V.								
*3 Output voltage cannot exceed the power supply voltage.								
*4 When the carrier frequency (F26) is set to below value or higher, it is necessary to derate the inverter nominal current.								
HHD spec ~22kW: 10kHz								
HND spec ~18.5kW: 10kHz, 22kW: 6kHz								
HHD spec. . . . type 0001 to 0011: 8kHz								
HND . . . type 0059: 10kHz, 0072, 0085, 0105, 0139, 0168: 6kHz, 0203: 4kHz								
*5 The value is calculated assuming that the inverter is connected with a power supply with the capacity of 500 kVA (or 10 times the inverter capacity if the inverter capacity exceeds 50 kVA) and %X is 5%.								
*6 Obtained when a DC reactor (DCR) is used.								

7.3 Three phase 200V class series (standard model)

Items		Specifications								
Type (FRN E2S-2_)		0001	0002	0004	0006	0010	0012	0020	0030	
Nominal applied motor [kW] ¹	HND	0,2	0,4	0,75	1,1	2,2	3,0 ⁹	5,5 ⁹	7,5	
	HHD	0,1	0,2	0,4	0,75	1,5	2,2	3,7	5,5	
Output ratings	Rated capacity[kVA] ²	HND	0,5	0,8	1,3	2,3	3,7	4,6 ⁹	7,5 ⁹	11
		HHD	0,3	0,6	1,1	1,9	3,0	4,2	6,7	9,5
	Rated voltage[V] ³	Three-phase 200 to 240V (With AVR)								
	Rated current [A] ⁴	HND	1,3	2,0	3,5	6,0	9,6	12 ⁹	19,6 ⁹	30
	HHD	0,8	1,6	3,0	5,0	8,0	11	17,5	25	
Overload capability	HND	120% of nominal current for 1min								
	HHD	150% of nominal current for 1min or 200% of nominal current for 0.5s								
AC input ratings	Main power supply	Three-phase 200 to 240V, 50/60Hz								
	Voltage/frequency variations	Voltage: +10 to -15% (Voltage unbalance:2% or less ⁸ , Frequency: +5 to -5%)								
	Rated current without DCR [A] ⁵	HND	1,8	2,6	4,9	6,7	12,8	17,9 ⁹	31,9 ⁹	42,7
		HHD	1,1	1,8	3,1	5,3	9,5	13,2	22,2	31,5
	Rated current with DCR [A] ⁵	HND	0,93	1,6	3,0	4,3	8,3	11,7 ⁹	19,9 ⁹	28,8
		HHD	0,57	0,93	1,6	3,0	5,7	8,3	14,0	21,1
Required power supply capacity [kVA] ⁶	HND	0,4	0,6	1,1	1,5	2,9	4,1 ⁹	6,9 ⁹	10	
	HHD	0,2	0,4	0,6	1,1	2,0	2,9	4,9	7,3	
DC	Voltage supply range	150 to 375 V								
DC reactor(DCR)	HND	Option								
	HHD	Option								
Enclosure (IEC60529)	IP20, UL open type									
Cooling method	Natural cooling				Fan cooling					
Mass [kg]		0,5	0,5	0,6	0,8	1,5	1,5	1,8	5,0	

Items		Specifications							
Type (FRN E2S-2)		0040	0056	0069	0088	0115			
Nominal applied motor [kW] ¹	HND	11	15	18,5	22	30			
	HHD	7,5	11	15	18,5	22			
Output ratings	Rated capacity[kVA] ²	HND	15	21	26	34	44		
		HHD	13	18	23	29	34		
	Rated voltage[V] ³	Three-phase 200 to 240V (With AVR)							
	Rated current [A] ⁴	HND	40	56	69	88	115		
		HHD	33	47	60	76	90		
Overload capability	HND	120% of nominal current for 1min							
	HHD	150% of nominal current for 1min or 200% of nominal current for 0.5s							
AC input ratings	Main power supply	Three-phase 200 to 240V, 50/60Hz							
	Voltage/frequency variations	Voltage: +10 to -15% (Voltage unbalance:2% or less ^{*8} , Frequency: +5 to -5%)							
	Rated current without DCR [A] ⁵	HND	60,7	80,0	97,0	112	151		
		HHD	42,7	60,7	80,0	97,0	112		
	Rated current with DCR [A] ⁵	HND	42,2	57,6	71,0	84,4	114		
		HHD	28,8	42,2	57,6	71,0	84,4		
Required power supply capacity ⁶ [kVA]	HND	15	20	25	30	40			
	HHD	10	15	20	25	30			
DC	Voltage supply range	150 to 375 V							
DC reactor(DCR)	HND	Option							
	HHD	Option							
Enclosure (IEC60529)		IP20, UL open type							
Cooling method		Fan cooling							
Mass [kg]		5,0	8,0	9,0	9,5	10			

*1 Fuji 4-pole standard motor. At the selection of the inverter rating, consider not only the rating capacity(kW) is enough but also inverter output current is larger than selected the motor's nominal current.

*2 Rated capacity is calculated by assuming the output rated voltage as 220 V.

*3 Output voltage cannot exceed the power supply voltage.

*4 When the carrier frequency (F26) is set to below value or higher, it is necessary to derate the inverter nominal current.

HND . . . 5.5~55kW: 10kHz, 75kW or above type of capacity: 6kHz

HND . . . 5.5~18.5kW: 10kHz, 22~55kW: 6kHz, 75kW or above type of capacity: 4kHz

HHD spec. . . . type 0001 to 0020: 8kHz, type 0030 to 0115: 10kHz,

HND spec. . . . type 0001 to 0020: 4kHz, type 0030 to 0069: 10kHz, type 0088, 0115: 4kHz

The rated output current at HD/ND spec. is decreased 2% for every 1 °C (1.8 °F) when ambient temperature is +40°C (+104 °F) or more.

*5 The value is calculated assuming that the inverter is connected with a power supply with the capacity of 500 kVA (or 10 times the inverter capacity if the inverter capacity exceeds 50 kVA) and %X is 5%.

Be sure to use the DCR when applicable motor capacity is 75kW or above.

*6 Obtained when a DC reactor (DCR) is used.

*8 Voltage unbalance (%) = (Max. voltage (V) - Min. voltage (V)) / Three-phase average voltage (V) × 67 (IEC 61800 - 3)

If this value is 2 to 3%, use an optional AC reactor (ACR).

*9 HND spec. of the type 0012 and 0020: allowable ambient temperature 40°C (+104 °F) or less.

The rated output current at HND spec. is decreased 1% for every 1 °C (1.8 °F) when ambient temperature is +40°C (+104 °F) or more.